

Spring 2011

Environmental Value Engineering Assessment of Horizontal Directional Drilling and Open Cut

Lameck Onsarigo

Follow this and additional works at: http://scholarworks.bgsu.edu/ms_tech_mngmt

 Part of the [Civil and Environmental Engineering Commons](#), and the [Construction Engineering Commons](#)

Recommended Citation

Onsarigo, Lameck, "Environmental Value Engineering Assessment of Horizontal Directional Drilling and Open Cut" (2011). *Master of Technology Management Plan II Graduate Projects*. Paper 6.

This Dissertation/Thesis is brought to you for free and open access by the College of Technology, Architecture and Applied Engineering at ScholarWorks@BGSU. It has been accepted for inclusion in Master of Technology Management Plan II Graduate Projects by an authorized administrator of ScholarWorks@BGSU.

ENVIRONMENTAL VALUE ENGINEERING (EVE) ASSESSMENT OF HORIZONTAL
DIRECTIONAL DRILLING (HDD) VERSUS OPEN-CUT.

By:

Lamech M. Onsarigo

A Major Project

Submitted to the Graduate College of Bowling Green

State University in partial fulfillment of the requirements for the degree of

MASTER OF TECHNOLOGY MANAGEMENT

May, 2011

Committee:

Dr. Wilfred Roudebush, Chair

Dr. Alan Atalah

Dr. C. Wayne Unsell

ABSTRACT

There has been a growing concern over the rate of deterioration of wastewater collection and water distribution systems in the United States. The ever-growing need for rehabilitation and replacement of these systems has led to the birth of a research program by the United States Environmental Protection Agency focused on addressing the water infrastructure needs. This program-Innovation and Research for Water Infrastructure for the 21st Century-lays emphasis on research focused on system rehabilitation.

There is a marked change in the way that the public view the environmental needs with 'green' becoming 'the new gold'. Man has been blamed, and rightfully so, for the global warming evidenced since the mid-20th century. Environmental impact and contribution assessment has now become a necessity, especially for major projects, both in rural and urban environments.

It is with this in mind that this study was carried out; its main purpose being to compare the environmental impact and contribution of both horizontal directional drilling (HDD) and open-cut construction methods during a pressurized water mains installation process. The study employed the use of the Environmental Value Engineering (EVE) methodology which, unlike any other environmental assessment method, accounts for the environmental inputs, fuel energy inputs, goods, and services to the alternatives competing for similar resources.

Environmental value engineering accounts for the inputs of environment, fuel energy, goods, and services in terms of EMERGY in units of solar emjoules (SEJ). EVE consists of the following ten life cycle phases: natural resource formation, natural resource exploration and extraction, material production, design, component production, construction (assembly), use, demolition,

natural resource recycling, and disposal. EVE was created, copyrighted, and developed by Dr. Wilfred H. Roudebush of Bowling Green State University, Bowling Green, Ohio.

The study which included all the inputs of the environment, fuel energy, goods, and services during the construction phase (F) of the life cycle for the competing alternatives, indicated that open-cut construction method used $8.71E+17$ SEJs as opposed to HDD's $2.90E+17$. This means that open-cut has 66.69% more impact on the environment than HDD. The data also indicated that there was a gross imbalance among the inputs of environment (E), fuel energy (F), goods (G), and services (S) that are used up in the construction phase for both horizontal directional drilling (alternative A) and open-cut construction method (alternative B).

To the almighty God who has been my sure rock, my guide and comfort through all and in all

ACKNOWLEDGEMENTS

My sincere and heartfelt appreciation goes to the following people who have been a great source of inspiration and have shown an extreme sense of patience with me during the course of this study. Their guidance, suggestions, comments and critique have played a major role in the success of this work.

Dr. Wilfred Roudebush

Associate Professor

Construction Management and Technology

Bowling Green State University

Dr. Alan Atalah

Associate Professor

Construction Management and Technology

Bowling Green State University

Dr. C. Wayne Unsell

Professor

Construction Management and Technology

Bowling Green State University

Special thanks also to my dad, family, and friends, who have been a constant source of motivation.

TABLE OF CONTENTS

CHAPTER 1	1
INTRODUCTION	1
Context of the problem.....	1
Statement of the problem	3
Objectives of the study	3
Significance of the study	4
Assumptions	5
Definitions.....	6
CHAPTER 2	8
LITERATURE REVIEW	8
Background	8
Horizontal Directional Drilling	9
HDD procedure.....	9
Open-cut	11
HDD versus open-cut: Other related studies.....	11
Cost-benefit analysis.....	12
Life cycle cost analysis (LCCA)	12
Carbon footprint	13
Environmental Value Engineering Overview	15
EMERGY Concept	16
EMERGY Transformities.....	16

Construction method inputs.....	18
EVE Life cycle phases.....	20
Hierarchical organization	25
Summary	25
CHAPTER 3	27
METHODOLOGY	27
Introduction.....	27
Research Design.....	27
Assessment of alternatives	29
Estimation of Inputs in HDD method (Alternative A)	29
Estimation of inputs in open-cut method (Alternative B)	32
EMERGY analysis	35
EMERGY input diagram.....	35
EMERGY analysis input tables.....	36
Summary EMERGY analysis input table.....	37
CHAPTER 4	39
FINDINGS.....	39
Environmental value engineering EMERGY calculations.....	39
Environmental value engineering EMERGY analysis input tables	39
Environmental value engineering summary EMERGY input table.....	43
Comparison of the construction method alternatives.....	43
HDD Vs Open-cut (With Native Backfill)	43
Native backfill Vs Imported backfill.....	44

Paved Vs Unpaved.....	46
Sensitivity to depth	47
Discussion	48
CHAPTER 5	51
SUMMARY AND CONCLUSIONS	51
Summary	51
Conclusions	51
Future research	52
REFERENCES	54
APPENDICES	56
APPENDIX A: ENVIRONMENTAL IMPACT EMERGY INPUT SOURCES.....	56
APPENDIX B: PIPELINE AND TYPICAL CITY STREET: PLAN.....	59
APPENDIX C: ENERGY SYSTEMS DIAGRAM SYMBOLS AND LANGUAGE	64
APPENDIX D: TRANSFORMITIES.....	66
APPENDIX E: EVE EMERGY ANALYSIS INPUT TABLES	69
APPENDIX F: ALTERNATIVE A CALCULATIONS (HDD)	75
HDD CALCULATIONS (Native Backfill).....	76
HDD CALCULATIONS (Imported Backfill).....	84
APPENDIX G: ALTERNATIVE B CALCULATIONS (OPEN-CUT).....	92
OPEN-CUT CALCULATIONS (Native Backfill).....	93
OPEN-CUT CALCULATIONS (Imported Backfill).....	99
OPEN-CUT CALCULATIONS (Unpaved).....	105
APPENDIX H: ASPHALT PAVEMENT TRANSFORMITY CALCULATIONS.....	111

APPENDIX I: DRILLING FLUID TRANSFORMITY CALCULATION 113

APPENDIX J: GLOSSARY 116

LIST OF TABLES

Table 1. Transformities table.....	17
Table 2. EVE life cycle phases.....	20
Table 3. HDD bores.....	30
Table 4. Environmental value engineering EMERGY analysis input table.....	37
Table 5. Environmental value engineering summary EMERGY table.....	38
Table 6. EVE EMERGY analysis input table for alternative A, HDD.....	40
Table 7. EVE EMERGY analysis input table for alternative B, Open-cut.....	41
Table 8. Environmental value engineering summary EMERGY input table.....	43
Table 9. Native backfill Vs Imported backfill.....	44
Table 10. Paved Vs Unpaved.....	46
Table 11. Sensitivity to depth (HDD).....	47
Table 12. Sensitivity to depth (Open-cut).....	47
Table 13. Ranking of EMERGY inputs.....	49

LIST OF FIGURES

Figure 1. HDD Operation.....	10
Figure 2. Energy systems diagram.....	19
Figure 3. Aggregated EMERGY diagram.....	24
Figure 4. Distribution of size and spatial pattern of units in each category in the hierarchy.....	25
Figure 5. Entry angle, sloped length and setback distance.....	30
Figure 6. Open-cut operation.....	33
Figure 7. Open-cut section.....	33
Figure 8. Asphalt pavement section.....	34
Figure 9. EVE EMERGY inputs for alternative A (HDD).....	42
Figure 10. EVE EMERGY inputs for alternative B (Open-cut).....	42
Figure 11. Comparison of the construction method alternatives.....	44
Figure 12. Native backfill Vs Imported backfill (Open-Cut).....	45
Figure 13. Native backfill Vs Imported backfill (HDD).....	45
Figure 14. Paved Vs Unpaved.....	47
Figure 15. Sensitivity to change in depth.....	48

CHAPTER 1

INTRODUCTION

Context of the problem

Eco-friendly, green, and ecological are among the many terms used in reference to the new era, towards sustainability, dawning in the construction industry as well as all other sectors.

A critical look into the future shows that there is a looming resource crisis. This crisis will be different from any other ever experienced before. It will not be a matter of the natural resources being too expensive to obtain, rather it will be a matter of absence of these resources. A good example would be fossil fuels. According to OPEC, crude oil demand on the international market was estimated at a staggering 87.70 million barrels per day in 2009. The fossil fuel time depletion is calculated to be around 35, 107, and 37 years for oil, coal and gas, respectively, by one proposed method (Shafiee & Topal, 2009).

Depletion, though an issue in the horizon, is not the only problem that we are facing today in relation to the environment. A present argument is that human activity is very likely the cause of global warming evidenced since the mid-20th century. The increase in CO₂ levels due to emissions from fossil fuel combustion is at the heart of this debate. Land use, air pollution, and deforestation also play a major role in this sensitive issue. Consequently, the debate has largely shifted onto ways to reduce further human impact on the environment and to find ways to adapt to the change that has already occurred over the past several decades.

Judging from history, human cultures contain the ability to switch from a regime that uses up stored resources to increase population, technological innovation, and civilization, to a quiescent

regime in which the environmental reserves of forests and soils re-grow. The 500-year cycle of the rise and decline of Mexico's Mayan civilization may be such an example. As environmental conditions change, the response of a system will adapt by optimizing, and not necessarily maximizing, its efficiency, so that maximum power output can be maintained (Odum&Odum, 2006).

The operation of technological societies is dependent upon the good use of the earth's resources and on economic developments that are compatible. Faced with the shortages of natural resources, pollution, overgrowth, and concern for protecting the environment, human beings are coming to realize that new concepts are needed to analyze the interdependent parts of the built environment as a whole (Roudebush, 1992).

In light of the present need for optimal use of our resources, as opposed to maximizing, there is an increasing shift of focus to system evaluation methodologies that can be used to evaluate the environmental impact of a product or system. It is with this ever-increasing need for products that are not only functional and cost-effective, but also environmental friendly, that environmental life cycle assessment is gaining popularity.

With the advance in technology comes a wide array of options in executing any single kind of job or project. For underground infrastructure, trenchless technologies offer an alternative to the traditional open-cut construction method. Traditional open-cut is still the most common method used in underground infrastructure. According Woodroffe& Ariaratnam (2008), its basic approach of excavating soil and laying pipe makes open-cut the option of choice in many instances over most of the trenchless methods including horizontal directional drilling (HDD) which was the focus in this study.

The intent of this study was to compare the environmental impact of horizontal directional drilling (HDD) and open-cut construction using the Environmental Value Engineering (copyright © Wilfred H. Roudebush 1990) methodology when installing one mile of 12 Inch- water-main six feet deep in an urban environment. The methodology was used to compare the inputs of the environment, fuel energy, goods, and services in terms of EMERGY for both HDD and open-cut construction. EMERGY is defined as all the available energy that was used in the work of making a product, including environmental impacts relating to inputs of: environment, fuel energy, goods, and services (labor) (Roudebush, 2003). This life cycle typically has ten phases: natural resource formation, natural resource exploration and extraction, material production, design, component production, construction (assembly), use, demolition, natural resource recycling, and disposal.

Statement of the problem

The purpose of this study was to compare the environmental impact of horizontal directional drilling (HDD) and open-cut construction alternatives using the environmental value engineering (EVE) methodology.

Objectives of the study

- To simulate water main installation along a street in a typical small or medium sized city in the United States. To this end, a representation of such installation was developed.
- To compare the contribution and the impact to the environment of horizontal directional drilling and open-cut construction methods, and to this end, an analysis was conducted, employing the environmental value engineering methodology.

- To determine how change in depth affects the environmental impact of both HDD and open-cut, and to this end, a sensitivity analysis was conducted.

Significance of the study

Lately, developers and decision makers are not only requiring the products to be functional and cost effective but also environmentally friendly. Advancement in the science of climate allows us to state, with confidence that the earth will warm during the next few centuries, which is of great concern to environmentalists. In line with this advancement in the science of climate is the growth of research into the present and future availability of mineral resources. The fact that these resources are finite and that man is consuming them at a faster rate than Mother Nature is able to re-grow them raises great concern to all parties involved from the producers to consumers. This concern triggers a shift of focus from maximizing the use of resources to optimizing that utilization. There is a need to responsibly manage energy and environmental resources in an effort to elude the looming crisis.

Currently, the most common method used for underground utility construction is traditional open-cut construction through the basic approach of excavating soil and laying pipe. Personnel training requirements are much less rigorous for open-cut construction than for horizontal directional drilling (HDD). When the traditional open-cut method is not acceptable or desirable, HDD practices are often applied. In situations with high investments in surface infrastructure, congested existing utilities, and where social costs such as commuter traffic and businesses are affected, HDD is a more desirable choice. The HDD process is also desirable in areas with multiple underground utilities and surface obstructions that cannot be disturbed (Woodroffe & Ariaratnam, 2008).

The need to responsibly manage energy and environmental resources calls for the use of evaluation tools to compare these competing alternatives with a view of adopting the most environmental-friendly choice. Traditional evaluation uses money. As stated by Odum (1988), money cannot be used directly to measure environmental contributions to the public good, since money is only paid to people for their services, not to the environmental service generating resources. Since money goes only to pay for human services, it is not utilized in environmental value engineering. Likewise, embodied energy cannot be used because it accounts only for fuel energy and does not include environmental, goods, or services input sources (Roudebush, 1997). EMERGY is the unit of quantification utilized in environmental value engineering, because it accounts for all the inputs of the environment, fuel energy, goods, and services.

Environmental life cycle assessment is a tool used to systematically evaluate the environmental impact of a system. The concept of life cycle assessment is to evaluate the environmental effects associated with any given activity from the initial gathering of raw material from the earth until the point at which all residuals are returned to the earth (“cradle to grave”). Environmental Value Engineering (EVE) is an environmental life cycle analysis methodology that evaluates the environmental impact and contribution of built alternatives in terms of solar energy joules (SEJ) over the life cycle (Roudebush, 1992).

The environmental value engineering methodology was used to compare environment, fuel energy, goods, and services input sources for both open-cut and horizontal directional drilling alternatives in this study.

Assumptions

The following assumptions were made in this research project:

1. The soil in which the pipe was installed was consistent, fairly stable soil- mixed soil (clay, sand and silt).
2. The length of the pipeline was one mile, the diameter of the pipe was 12 inch, and the depth of installation was six feet.
3. The pipe materials were not significantly different to include in the EMERGY calculations

The following were deemed beyond the scope of this study:

1. Inputs arising from traffic disruption and delays.
2. Social costs.
3. Connection from water main pipeline to homes.

Definitions

Environmental Value Engineering

Environmental value engineering (EVE) is an environmental life cycle analysis methodology that evaluates the environmental impact and contribution of built alternatives in terms of EMERGY through ten life cycle phases namely: natural resource formation, natural resource exploration and extraction, material production, design, component production, construction (assembly), use, demolition, natural resource recycling, and disposal. According to Roudebush (1992), built environment alternatives requiring the least EMERGY help drive the society toward sustainable development.

EMERGY

EMERGY is defined as all the available energy that was used in the work of making a product, including environmental impacts relating to inputs of: environment, fuel energy, goods, and services (labor) (Roudebush, 2003). EMERGY is a scientific based measure of wealth that puts raw materials, commodities, goods, and services on a common basis, the energy of one kind (usually solar) that has to be used up directly and indirectly to make a product or service (Odum&Odum, 2006). EMERGY is expressed in standard units of energy called solar emjoules (SEJ).

Horizontal Directional Drilling

Horizontal Directional Drilling (HDD) is a trenchless methodology that provides an installation alternative with minimal surface disturbance. HDD consists of a rig that makes a pilot bore by pushing a cutting or drilling head that is steered and guided from the surface. Drilling fluid is pumped through a nozzle in the drill head to cut and displace the soil. When the pilot bore is completed, a pulling back reamer enlarges the hole. Progressively larger back-reamers are used until the hole is large enough to pull the product into place.

Life Cycle Assessment

Life cycle assessment is a technique to assess each and every impact associated with all the stages of a process from cradle-to-grave (i.e., from raw materials through materials processing, manufacture, distribution, use, repair and maintenance, and disposal or recycling). The use of LCA's primarily helps avoid limited outlook on environmental, social, and economic inputs and concerns.

CHAPTER 2

LITERATURE REVIEW

Background

The quest for national development, economic growth, and heightened living standards are inseparably linked to environmental conditions. Wise use of natural resources and environmental protection are a prerequisite in this day and age. Economic growth and development, and the potential for such growth, is endangered by a natural resource base declining in quality as well as quantity.

Judging from history, human cultures contain the ability to switch from a regime that uses up stored resources to increase population, technological innovation, and civilization, to a quiescent regime in which the environmental reserves of forests and soils re-grow. As environmental conditions change, the response of a system will adapt by optimizing, and not necessarily maximizing, its efficiency, so that maximum power output can be maintained (Odum&Odum, 2006).

In light of the present need for optimal use of our resources, as opposed to maximizing, there is an increasing shift of focus to system evaluation methodologies that can be used to evaluate the environmental impact of a product or system. The essence is to have a system evaluation methodology that can be used to compare environmental impact of competing alternatives and create a baseline for decision making. It is with this ever-increasing need for products that are not only functional and cost-effective, but also environmental friendly, that environmental life cycle assessment is gaining popularity

Horizontal Directional Drilling

HDD is a steerable trenchless construction method that offers an alternative for installing underground pipes, conduits and cables. The method is used to install pipes, conduits, and cables along a prescribed bore path by using a surface launched drilling rig. In urban settings with dense populations, businesses, and local residents usually suffer from inconveniences caused by impacts to traffic flow, delays, and by the construction. Traffic detours, noise, impacts to business operations/access/parking, and air pollutants are the most notable distresses on the public (Woodroffe& Ariaratnam, 2008). HDD offers an alternative that gets the job done without causing these inconveniencies

HDD consists of a rig that makes a pilot bore by pushing a cutting or drilling head that is steered and guided from the surface. Drilling fluid is pumped through a nozzle in the drill head to cut and displace the soil. When the pilot bore is completed, a pulling back reamer enlarges the hole. Progressively larger back-reamers are used until the hole is large enough to pull the product pipe (Kariuki, 2009).

HDD can be used to install product pipes ranging in sizes between 2 inch and 63 inch.

Installations exceeding 1800m (6000 ft) have been completed successfully using HDD. Pipe materials commonly installed by HDD would include HDPE, PVC, ductile iron, and steel.

HDD procedure

The HDD procedure consists of three stages as shown in Figure 1:

- Pilot bore and tracking
- Reaming/Hole enlargement

- Pullback

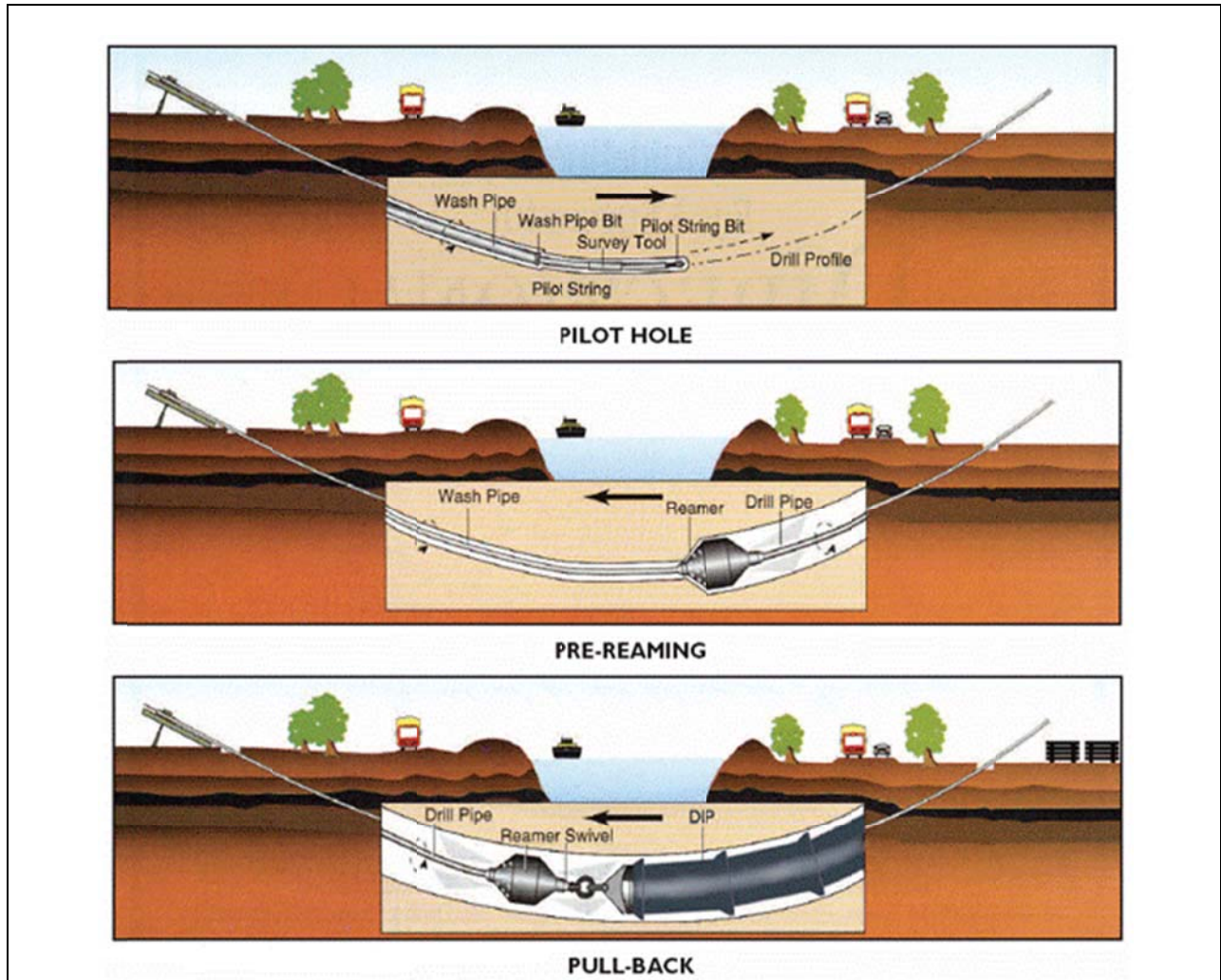

Figure 1. HDD Operation.

Once the rig is set up, a small entry pit is excavated to facilitate entry of the bit at the desired angle and help contain the drilling fluid. The pilot bore is drilled along the prescribed bore path from the entry point to the exit. If the pilot bore is to be enlarged, a reamer is attached to the drilling pipe. The reamer is rotated and pulled (or pushed in some cases) to enlarge the bore to the desired size. Increasing reamers are used to enlarge the bore to the desired size-usually 1.5 times the size of the product pipe. Once the desired bore is achieved, a pulling head is attached to

the product pipe. A swivel is put between the product pipe and the reamer to transfer the pulling force and not the torque-this prevents rotation of the product. The product is then pulled back in place. The drilling fluid is used to assist in both boring and back-reaming

Open-cut

Currently, the most common method used for underground utility construction is traditional open-cut construction due to the basic approach of excavating soil and laying pipe. Personnel training requirements are much less rigorous for open-cut construction than for horizontal directional drilling (HDD). When the traditional open-cut method is not acceptable or desirable, HDD practices are often applied (Woodroffe and Ariaratnam, 2008).

Open-cut construction involves three stages:

- Digging a trench,
- Placing pipe, duct or cable in the trench, and
- Filling in the excavation.

It can get a little more complicated when unstable ground conditions are encountered necessitating shoring. In places where surface damage is not an issue and the ground is not muddled with utilities; open-cut construction usually is the least expensive and most cost effective way to install a product.

HDD versus open-cut: Other related studies

An in-depth search for previous research on this topic was conducted. A search was run on the web of science, Google scholar, academic search complete, and compendex databases. Each of

these databases contain citations to scholarly articles and papers on numerous topics from thousands of international and local journals, technical reports, and conference proceedings and papers. No papers were found from the searches that compare life cycle environmental impacts of open-cut and trenchless technologies.

Cost-benefit analysis

Cost-benefit analysis (CBA) or benefit-cost analysis (BCA) is a method that can be used to choose the most feasible choice between or among competing alternatives. The CBA method weighs the total expected costs against the total expected benefits of a given alternative in an effort to determine its feasibility.

There are distinct differences between cost-benefit analysis and environmental value engineering. These include:

1. Costs in the cost-benefit analysis are measured in monetary terms while environmental value engineering uses EMERGY. Money only pays for services (labor).
2. Cost-benefit analysis does not consider environmental inputs.
3. Cost-benefit analysis does not consider the entire life cycle of the competing alternatives.

Life cycle cost analysis (LCCA)

Life cycle cost analysis is a method used to analyze the total cost, from acquiring, using, and disposing of a given alternative. Life Cycle Cost is the total discounted dollar cost of owning, operating, maintaining, and disposing of a project alternative over a period of time. The costs involved here would include:

1. Initial (acquisition) costs,
2. Operation and maintenance costs,
3. Replacement costs,
4. Loan interest payments, and
5. Salvage value.

The difference between life cycle cost analysis (LCCA) and environmental value engineering (EVE) are:

1. LCCA considers a limited life cycle period in comparison to the EVE life cycle phases earlier mentioned in this paper.
2. Costs in LCCA are measured in monetary terms while environmental value engineering uses EMERGY. Again, money only pays for services (labor).
3. LCCA does not include environmental inputs in the analysis

Carbon footprint

Carbon footprint is a measure of greenhouse gas (GHG) emissions-in this case carbon dioxide-caused directly and indirectly by a person, organization, event, or product. Burning of fossil fuels is one of the biggest contributors to GHG emissions. Consideration of carbon footprint can aid one select a product, system, or method that does not have a significant effect on climate change.

There are distinct differences between carbon footprint and environmental value engineering which would include:

1. Carbon footprint considers fuel energy inputs alone. Inputs of the environment, goods, and services (labor) are not considered.

2. Carbon footprint does not consider the life cycle phases earlier described in this paper.

Comparisons in terms of cost and GHG emissions have generated a lot of interest to researchers in the construction industry in an effort to weigh open-cut methodology against trenchless technologies.

Kariuki (2009) used the cost-benefit analysis to compare open-cut and horizontal directional drilling (HDD) in pressurized waterline installations in Nairobi, Kenya. His findings indicated that the cost of HDD was 12.78% higher than the cost of open-cut. It was further indicated that the cost of materials for the HDD estimate carried a considerable amount of the project costs in comparison with the open-cut estimate since the materials were imported.

Rehan and Knight (2007) sought to answer the question, “Do trenchless pipeline construction methods reduce greenhouse gas emissions?” Their preliminary analysis found that the use of trenchless construction methods can result in 78 to 100 percent lower green house gas emissions than open-cut pipeline installation methods. This is attributed to shorter job duration using less construction equipment and limited or no disruption to traffic flow when using trenchless. Their estimate did not include greenhouse gas emissions resulting from: the production and transportation of additional quantities of asphalt concrete and trench restoration materials; loss of pavement life; and/or pavement maintenance and rehabilitation.

Gangavarapu, Najafi, & Salem (2004) compared the traffic delays and costs involved during utility construction using open-cut and trenchless methods. Case studies of two sites involving utility construction were considered in the study.

No work was found that compares the environmental impact of open-cut and trenchless technologies through the life cycle from natural resource formation through to disposal.

Environmental Value Engineering Overview

Environmental value engineering (EVE) is an environmental life cycle analysis methodology that evaluates the environmental impact and contribution of built alternatives in terms of solar EMERGY through ten life cycle phases namely: natural resource formation, natural resource exploration and extraction, material production, design, component production, construction (assembly), use, demolition, natural resource recycling, and disposal. Environmental value engineering enables one to select alternatives that minimize environmental impact towards a sustainable society.

Environmental value engineering was developed by Dr. Wilfred H. Roudebush (1992) to aid in analyzing the environmental role of built environment alternatives. This evaluation system combines Dr. Howard T. Odum's EMERGY analysis with the traditional value engineering. A built environment alternative uses the earth's renewable and nonrenewable resources throughout its life cycle, from natural resource formation to final disposition. EVE evaluates the environmental contribution (value) and impact of built environment alternatives in units of solar EMERGY over the life cycle consisting of ten phases. The sum of EMERGY contributions to each phase is added as an input to the next. EMERGY accumulates from one phase to the next (Roudebush, 1992).

EMERGY Concept

The most abundant source of energy on earth is sunlight, but because it is spread out in time and space, it is low quality compared to the many other forms of energy on earth derived from it. Many solar joules are required to make other kinds of concentrated energy, the kinds that humans need. It is convenient to express all other kinds of energy on earth in terms of the sunlight energy required directly and indirectly. For this reason, EMERGY (spelled with an 'M') was introduced (Odum&Odum, 2006). EMERGY, a measure of real wealth, is defined as the sum of the available energy of one kind previously required directly or indirectly through input pathways to make a product or service (Odum, 2000). In this paper solar EMERGY is used. The unit of solar EMERGY is the *Solar Energy Joule* or *solar emjoules*(SEJ), to distinguish it from the regular joule (J) and to point out a different quality assessment based on a donor side point of view (Odum, 2006).

EMERGY Transformities

A transformity is defined as the EMERGY (in solar emjoules) of one kind of available energy required directly or indirectly (through all the pathways required) to make one joule of energy of another type (solar emjoules/joule), a given unit weight (solar emjoules/gram), or a given currency (solar emjoules/United States dollar). Transformity is the ratio of EMERGY to available energy (Odum, 1998). Solar transformity is the solar EMERGY per unit product or output flow. Transformities (EMERGY conversions) for energies, resources, and commodities related to the built environment and this research project are summarized in Table 1 that follows.

Refer to notes 1 and 2 unless otherwise noted)					
MATERIAL	UNIT	TRANSFORMITIES	UNIT	TRANSFORMITIES	
Aluminum ingots	(g)	1.60E+10	(lbs)	7.26E+12	
Asphalt	(J)	3.47E+05			
Asphalt Concrete	(g)	1.78E+09	(lbs)	8.07E+11	
Cement	(g)	3.30E+10	(lbs)	1.50E+13	
Clay	(g)	1.71E+09	(lbs)	7.76E+11	
Coal	(J)	3.98E+04			
Concrete	(g)	9.99E+08	(lbs)	4.53E+11	
Copper	(g)	6.80E+10	(lbs)	3.08E+13	
Drilling Fluid	(lbs)	3.02E+10	(gal)	2.52E+11	(Refer to note 4)
Electricity	(J)	1.59E+05			
Fertilizer	(g)	1.20E+10	(lbs)	5.44E+12	
Iron	(g)	1.80E+09	(lbs)	8.16E+11	
Limestone	(g)	1.62E+06	(lbs)	7.35E+08	
Machinery	(g)	6.70E+09	(lbs)	3.04E+12	
Mulch	(g)	1.71E+09	(lbs)	7.76E+11	
Natural gas	(J)	4.80E+04			
Oil	(J)	5.30E+04			
Paper	(J)	2.15E+05			
Petroleum product	(J)	6.60E+04	(gal)	1.00E+13	
Plastic	(g)	3.20E+09	(lbs)	1.45E+12	
Polymers	(g)	3.20E+09	(lbs)	1.45E+12	
Rubber	(g)	4.30E+09	(lbs)	1.95E+12	
Soda Ash	(g)	1.62E+06	(lbs)	7.35E+08	
Seed	(g)	4.71E+09	(lbs)	2.14E+12	
Service, labor	(\$)	1.10E+12	(\$)	1.10E+12	(Refer to note 3)
Steel	(g)	1.80E+09	(lbs)	8.16E+11	
Stone, mined	(g)	1.00E+09	(lbs)	4.54E+11	
Stone, natural state	(g)	8.50E+08	(lbs)	3.86E+11	
Topsoil	(g)	1.71E+09	(lbs)	7.76E+11	
Water	(g)	7.28E+04	(gal)	2.76E+08	
Wood	(J)	3.49E+04			

Table 1. Transformities table.

NOTES:

1. Transformity units are solar emjoules/joule, solar emjoules/gram, solar emjoules/ gal, solar emjoules/ lb, or solar emjoules/US \$
2. Source: Dr. Howard T. Odum, Department of Environmental Engineering Sciences, University of Florida, Gainesville, Florida.
3. Units in 1998 U.S. dollars.
4. The transformity for the drilling fluid is specific to this mix ratio. {See Appendix I}

Construction method inputs

The term “Construction method,” includes all alternatives that consume environment (E), fuel energy (F), goods (G), and services (S) inputs (in this case, HDD and open-cut alternatives). This is expressed in the energy systems diagram shown in Figure 2. Money circulates in the system to pay only for services (labor) rendered by human population. Money is not paid to the environment, and money paid to the people cannot be used to evaluate benefits or losses to the environment (Roudebush, 1992). This is because money is paid to the people for the human services and not to the environmental service generating resources.

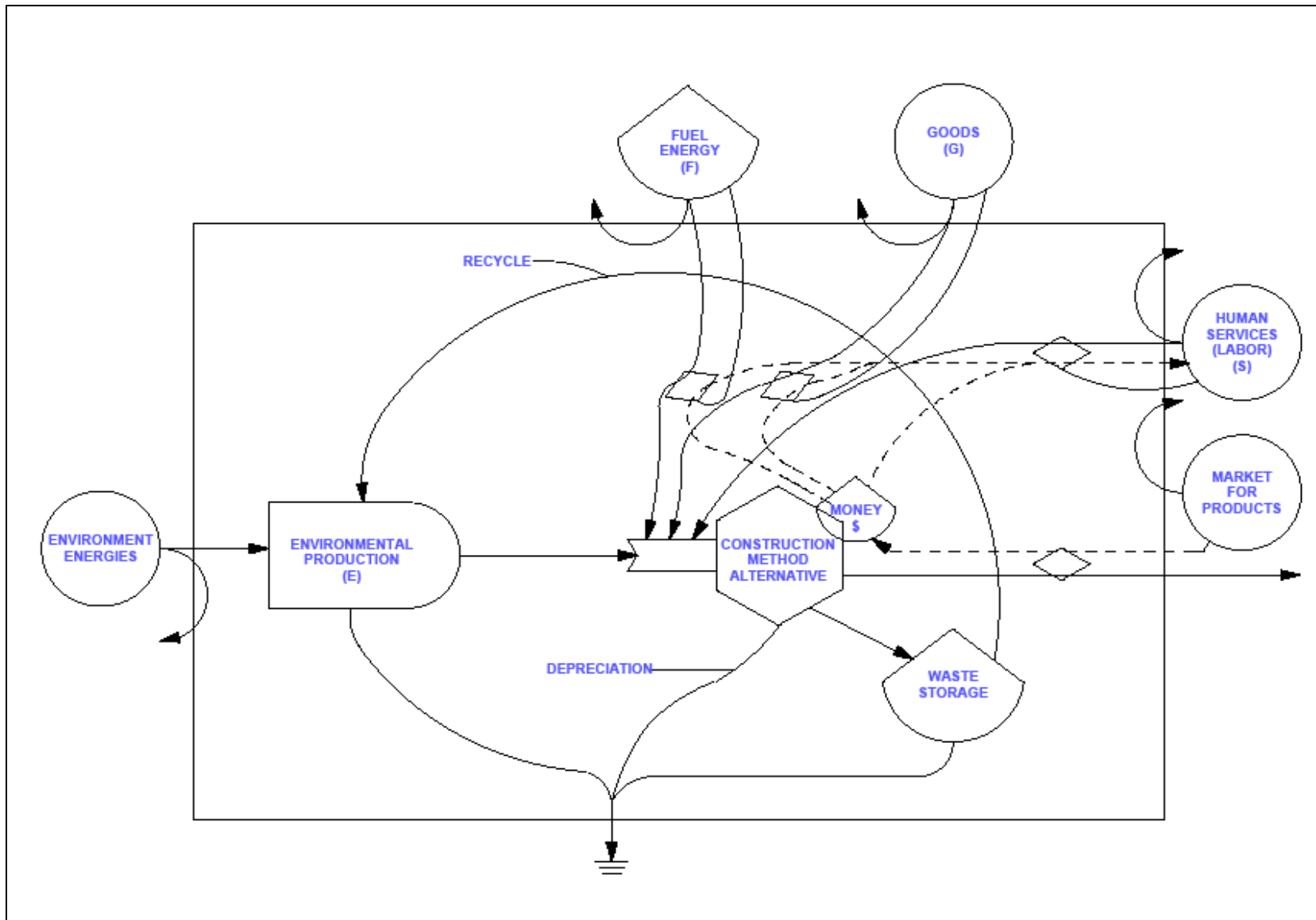

Figure 2. Energy systems diagram, (Roudebush 1997)

EVE Life cycle phases

The 10 phases of EVE, in table 2 below, are based upon different production and consumption processes taking place within each phase. These production and consumption processes have distinct categorical environmental impact input requirements of environment (E), fuel energy (F), goods (G), and services (S) (Roudebush, 1997).

PHASE A	NATURAL RESOURCE FORMATION
PHASE B	NATURAL RESOURCE EXPLORATION & EXTRACTION
PHASE C	MATERIAL PRODUCTION
PHASE D	DESIGN
PHASE E	COMPONENT PRODUCTION
PHASE F	CONSTRUCTION
PHASE G	USE
PHASE H	DEMOLITION
PHASE I	NATURAL RESOURCE RECYCLING
PHASE J	DISPOSAL

Table 2. EVE life cycle phases (Roudebush, 1992).

Phase descriptions follow from Roudebush (1997):

Phase A: Natural resource formation

This phase involves the production and consumption of various environmental systems (ecosystems, geology systems, etc.). For a given construction method alternative, the natural resources would include minerals, which are formed by the earth processes over millions of

years, and biomass, resulting from living organism net production occurring over shorter periods of time.

Phase B: Natural resource exploration and extraction

This phase includes EMERGY of environment, fuel energy, goods, and services inputs occurring during natural resource exploration and extraction processes. Environmental impacts assignable to this phase include renewable environmental inputs in the form of land used during extraction and storage of extracted natural resources. Reclamation of land, after natural resource extraction, and transportation of natural resources for material production is included in this phase.

Phase C: Material production

This phase includes EMERGY of environment, fuel energy, goods, and services inputs occurring during material production. This includes conversion of natural resources into materials used for the component production of a construction method alternative. Some materials are produced directly into standardized components such as structural steel, windows, doors, and roofing components.

Phase D: Design

This phase includes EMERGY of environment, fuel energy, goods, and services inputs occurring during architectural and engineering design of the construction method alternative.

Phase E: Component production

This phase includes EMERGY of environment, fuel energy, goods, and services inputs occurring during component production. Component production is conducted by the manufacturing

facilities specializing in various construction method alternative components. Components produced on site are included in the construction phase instead of the component production phase. A good example would be in-situ concrete as opposed to prefabricated concrete panels.

Phase F: Construction

Environment, fuel energy, goods, and services inputs occurring during the construction phase are dependent upon such factors as type of construction, techniques of construction, time of construction, quality of materials, components and subsystems, and workmanship. Construction related environmental impacts, such as construction wastes, are accounted for during this phase. This phase also includes work done during the guarantee and warranty periods of the construction contract, which commence at the beginning of the use phase.

Phase G: Use

This phase includes EMERGY of environment, fuel energy, goods, and services inputs occurring during the use, operation, and maintenance up to time of demolition. Included are financing, maintenance, operation, alteration, repair, replacement, tax elements, insurance, and any other activities that require EMERGY inputs. The use phase includes the period of time from the substantial completion of the construction to the demolition phase. Included are the periods of nonuse or abandonment. The use phase is affected by quality of materials, decisions on utilization of recycled materials, components, and subsystems, and phase duration.

Phase H: Demolition

This phase includes EMERGY evaluation of environment, fuel energy, goods, and services inputs used to demolish and remove the materials, components, and systems during this phase.

Currently, most construction materials, components, and subsystems are disposed of in the form of demolition debris during the demolition phase. The EMERGY for disposal is accounted for in phase J (disposal phase).

Phase I: Natural resource recycling

This phase includes EMERGY of environment, fuel energy, goods, and services inputs used to recycle materials, components, and systems. EMERGY inputs can be reduced if recycling increases natural resource formation (Phase A), and decreases natural resource exploration and extraction (Phase B), material production (Phase C), component production (Phase E), and disposal (Phase J).

Phase J: Disposal

This phase includes EMERGY of environment, fuel energy, goods, and services inputs occurring during the disposal of materials, components and systems. Included in the evaluation are demolition debris placement, demolition debris compaction, demolition debris landfill containment, landfill closure, and landfill post-closure.

An aggregated EMERGY input diagram, shown in figure 3, represents the total source inputs of EMERGY from environment (E), fuel energy (F), goods (G), and services (S) for the alternatives under study over the 10 environmental value engineering life cycle phases. Components within the aggregated EMERGY input diagram boundary represent EMERGY accumulations that occur within each environmental value engineering life cycle phase.

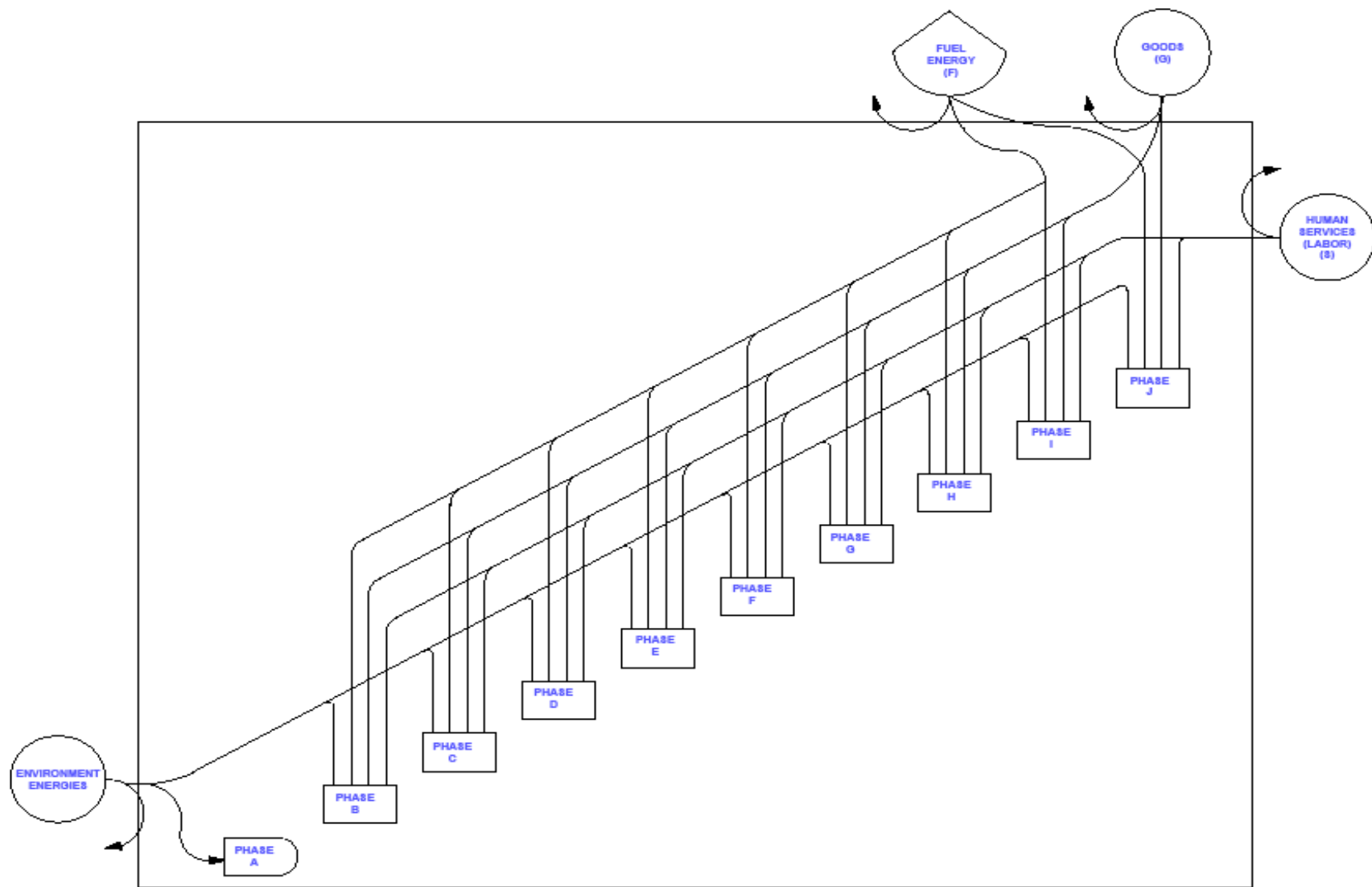

Figure 3. Aggregated EMERGY diagram (Roudebush, 1992).

Hierarchical organization

Energy transformations generate hierarchies over production chains. The diagramming process below (figure 4) shows an energy transformation hierarchy with large flows of low-quality energy being converged and transformed into smaller and smaller volumes of higher and higher quality types of energy. Engineering practice already recognizes that it takes four joules of coal to make one joule of electrical energy (Odum, 1988).

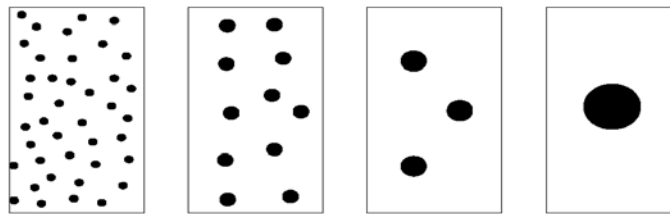

Figure 4. Distribution of size and spatial pattern of units in each category in the hierarchy (Odum, 1988).

Each phase of a built environment alternative forms a portion of an EMERGY hierarchy for that alternative. At each phase, the energy is degraded as a necessary part of transforming a lower quality energy to a higher quality one in lesser quantity. Energy flows decrease as one goes up the chain.

Summary

Today, methods, systems, components, and products that have low negative impact on the environment are gaining popularity among consumers as well as producers. Faced with the

impending depletion of resources and the heightened concern for protection of the environment, it is not only expedient, but also imperative that environmental life cycle assessment of competing alternatives be a requisite measure in decision making.

Other researchers in the construction industry have made considerable progress on social and environmental cost comparisons between the open-cut method and trenchless technologies.

Comparison of these alternatives on the basis of carbon emissions, though not conclusive, has also been done. As indicated earlier in this research project, there are papers that have compared the life cycle costs resulting from both trenchless technologies and open-cut. However, no papers were found that used environmental value engineering or any other environmental life cycle analysis methodology to compare horizontal directional drilling and open-cut construction.

CHAPTER 3

METHODOLOGY

Introduction

The purpose of this research project was to compare the environmental impact of horizontal directional drilling (HDD) and open-cut construction alternatives using the environmental value engineering (EVE) methodology.

The objectives were:

- To simulate water main installation along a street in a typical small or medium sized city in the United States. To this end, a model was developed.
- To compare the contribution and the impact to the environment of horizontal directional drilling and open-cut construction methods, and to this end, an analysis was conducted, employing the environmental value engineering methodology.
- To determine how change in depth affects the environmental impact of both HDD and open-cut, and to this end, a sensitivity analysis was conducted.

Research Design

In order to realize these objectives, a model was designed simulating a water main installation along a typical city street in the United States (Refer to Appendix B for plans of pipeline and typical city street). The project was defined as follows:

1. Length of one mile for both alternatives (Open-cut and HDD).
2. 12 inch diameter water main pipe for both alternatives.

3. Six feet invert for both alternatives.

For the purpose of this study, the following assumptions were made:

1. The equipment used will not be recycled but will be used until they do not have any operational value.
2. The yard was 50 miles and 75 miles from the construction site for open-cut and HDD respectively (We have considerably more open-cut contractors which reduces their area of operation).
3. There was an existing water main and it was being replaced by the new one (see Appendix B).
4. Mixed soil condition –predominantly clay of average stiffness with some silt and sand in its formation.
5. All other life cycle phases, with the exception of the construction phase (F), are not significantly different.
6. Inputs for connections to homes and other lateral connections are similar for both alternatives and are therefore not included in this research project. The connections were to be done by open-cut irrespective of the method used to install the main line.
7. A shrinkage factor of 10% for the foreign backfill material, here defined as 304 limestone.
8. A swell factor of an average 25% for the native soil, here defined as common-predominantly clay of average stiffness with some silts and sand (Peurifey & Oberlander, 2002).

Assessment of alternatives

In order to compare the environmental impact of both HDD and open-cut, environmental value engineering was used to evaluate both alternatives. Alternative A was the horizontal directional drilling construction method alternative and alternative B was the open-cut construction method alternative.

Excel spreadsheets were prepared and tailored to aid in the calculation of the EMERGY inputs required for these competing alternatives over the construction phase of their life cycle (appendix F & G). The data was then input into the EMERGY input tables for unit conversion to SEJs (appendix E). Data from the EMERGY input tables was then input into the EMERGY summary table for comparison purposes.

Estimation of Inputs in HDD method (Alternative A)

In the estimation of the inputs into the HDD alternative, the project was divided into 12 sections guided by the number of fire hydrants required for the entire length. An entry angle of 8° was assumed based on the rig size, the available space for setback, and the invert desired. The bore lengths were then adjusted based on this entry angle as shown in Figure 5 and Table 3 below.

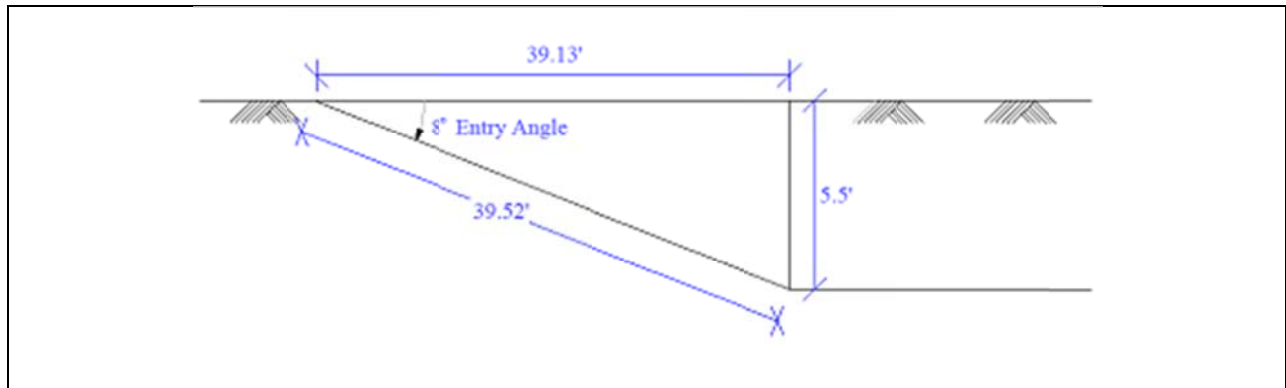

Figure 5. Entry angle, slopes length and setback distance.

HDD Bores					
	Number of bores	Length Of Bore	Adjusted lengths	Number of joints	Displaced fluid length
	1	270	349.04	6	309.52
	2	300	379.04	14	339.52
	2	400	479.04	18	439.52
	1	450	529.04	11	489.52
	1	460	539.04	11	499.52
	1	500	579.04	12	539.52
	4	550	629.04	52	589.52
Totals	12	2930	3483.27	135	3206.63

Table 3. HDD bores.

HDPE pipe DR 11, with a pressure rating of 160 psi, was the pipe of choice for this operation. This is the recommended pressure rating for water main installation. The construction process was broken down into the following steps: mobilization, equipment setup, pilot bore and tracking, reaming 12 inch, reaming 18 inch, pipe layout and fusion, pullback, connection, restoration and clean-up, and demobilization. Inputs of environment, fuel energy, goods, and services were calculated for each activity in the construction phase.

The formulas below were used in the HDD calculations for the drilling and reaming operations.

$$V = (D^2/25)$$

Where:

V is hole volume in gal/ ft, and

D is bore diameter in inches

$$t_{min} = (V \times \text{Flow Factor}) / (\text{Pump Rate} \times \text{Pump Efficiency})$$

Where:

t min is the fastest drilling/ reaming rate, and

Flow Factor = 3 (Based on soil type) HDD Consortium (2004).

Following manufacturer guidelines, the drilling fluid used was assumed to have the following composition:

- Bentonite (Montmorillonite clay) = 30 lbs/ 100 gal of water
- PHPA Polymer (Stabilizer for shale and clay) = 0.5 lbs/ 100 gal of water
- Dry cellulosic polymer (For filtration control) = 1.5 lbs/ 100 gal of water
- Soda Ash (Na_2CO_3) = 1.5 lbs/ 100 gal of water

The transformity for the drilling fluid was calculated as **2.52E+11 sej/ gal** { Appendix I}

The following equipment, necessary for the entire operation, was selected following guidelines from the horizontal directional drilling good practices guidelines, HDD Consortium (2004).

- Drill Rig: Ditch witch JT4020,
- Two Mixing Systems: Ditch Witch FM 13V fluid management,
- Backhoe Loader: John Deere 410J,
- Fusion machine: Mc Elroy TracStar No. 618 Rolling,
- Vacuum truck: Vactor Hydro-Excavator PD,
- Dump truck: Mercedes-Benz Actros
- Three Haul Trucks: Mercedes-Benz Actros
- Plate Compactor: Dynapac LG300 24 inch x 29 inch

Manufacturer's data was used to establish the weight, fuel consumption, life expectancy, and capacity of each of the equipment. This information was crucial in determining the quantity of the inputs of both fuel energy and goods in every activity.

Estimation of inputs in open-cut method (Alternative B)

In the estimation of the inputs in the open-cut construction method alternative, the construction process was broken down into the following activities: mobilization, asphalt pavement saw cutting & ripping, trench excavation, shoring, placing bedding material & laying pipeline, backfilling & compacting, restoration & site cleanup, and demobilization. Inputs of environment, fuel energy, goods, and services were also calculated for each activity in the construction phase.

Excavation, shoring, placing the bedding material, laying the pipe, and backfilling were assumed to be carried out concurrently as illustrated in Figure 6 below with work being carried out on a 60 foot length at any one given time.

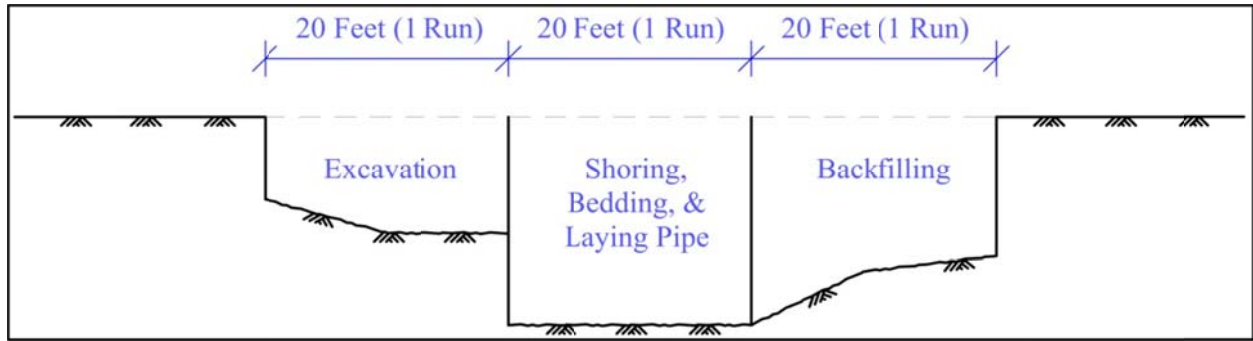

Figure 6. Open-cut operation.

The trench was 30 inch wide allowing 9 inch beyond the pipe on either side for easy access to the pipe during pipe laying as shown in Figure 7. A 12 inch wide affected area was added onto the restoration of the pavement on both sides of the trench to allow joining the new pavement to the existing.

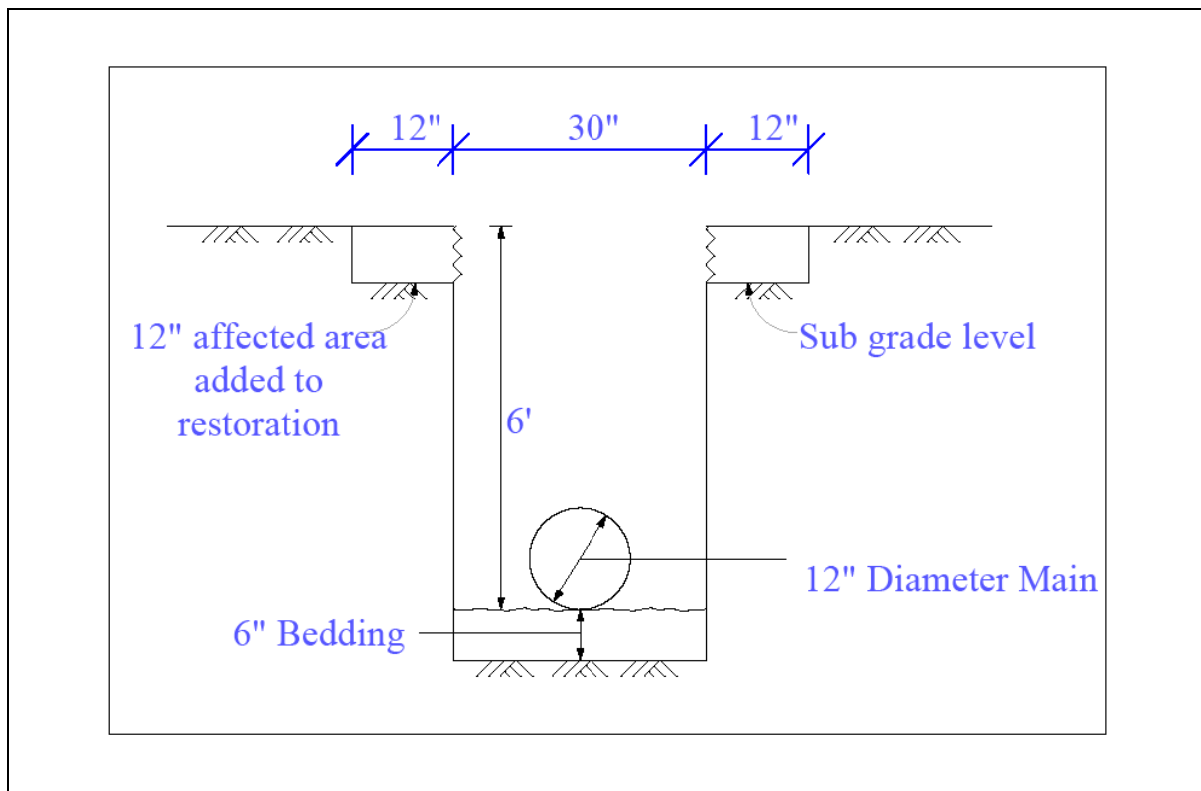

Figure 7. Open-cut section.

The pavement transformity used in this study was taken from Roudebush (1997). Roudebush (1997) compared concrete and asphalt pavement system alternatives. The pavement alternatives were both 24 feet wide by 3280.8398 feet (1kilometer) long. The EMERGY for the asphalt alternative was computed to be $2.08E+19$. This study adopted a similar asphalt pavement with input transformities of:

- $1.66E+14$ for the environmental inputs
 - $3.46E+13$ for the fuel energy inputs
 - $3.16E+13$ for the inputs goods
 - $3.19E+13$ for the inputs of services
- { Appendix H }

Figure 8 below shows a cross section of the asphalt pavement system used in Roudebush (1997) and adopted in this study for the asphalt pavement repair.

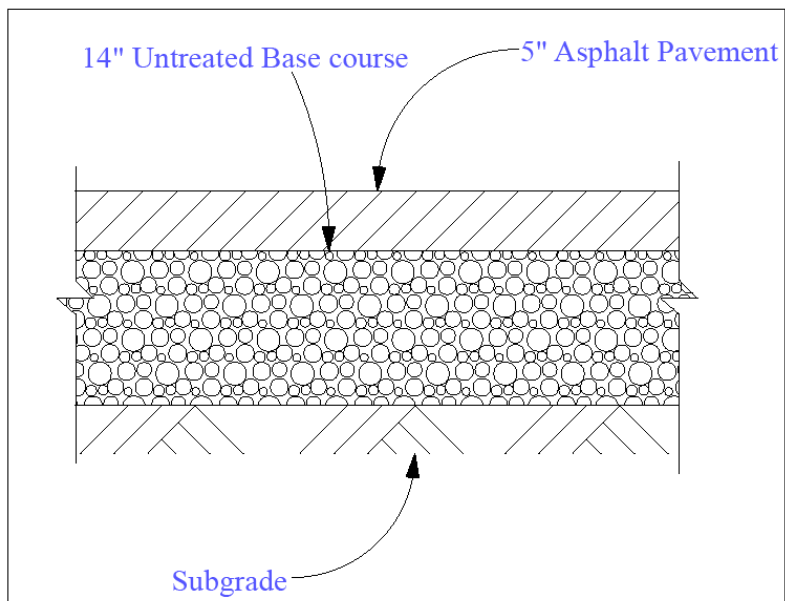

Figure 8. Asphalt pavement section (Roudebush, 1997).

The following equipment was selected and used in the estimation for the open-cut method:

- Four dump trucks: Mercedes-Benz Actros
- Three haul trucks: Mercedes-Benz Actros
- Excavator: CAT 324 D
- Backhoe Loader: John Deere 410J
- Asphalt Saw: Dynapac ORKA 350/450
- Wheel loader: CAT 950H

Manufacturer's data was used to establish the weight, fuel consumption, life, and capacity of each of the equipment. This information was crucial in determining the quantity of the inputs of both fuel energy and goods in every activity.

EMERGY analysis

The EMERGY analysis was done by application of the environmental value engineering methodology which involved the following items briefly described in order below.

- EMERGY input diagram
- EMERGY analysis input tables

EMERGY input diagram

The energy systems diagram (refer to Figure 2) was used to portray the various EMERGY input sources to the alternatives in this study. External to the energy system boundary are energy input sources, which are arranged from lowest quality in the lower left corner, then clockwise to the highest quality input source in the lower right corner. The bottom of the energy system diagram

boundary is used only for the dispersion of potential energy into heat (second law of thermodynamics), which is indicated by a heat sink symbol. Within the energy system boundary are producers, consumers, and storages which ascend in energy quality (EMERGY content) from left toward the right. Relationships between these producers, consumers, and storages are indicated by energy circuits or pathways of energy flow (Roudebush, 1997).

EMERGY analysis input tables

EMERGY analysis input tables were used for the construction phase under study for alternatives, HDD and open-cut. Table 4 below is one such table with cells for all inputs of environment, fuel energy, goods, and services. Multiplying the raw units (column four) with the appropriate transformity (column five) gave the EMERGY values (column six) in solar emjoules (SEJs).

	Item	Units	Raw Units (g, J, \$, gal, lbs)	Transformity (SEJs/ unit)	Solar EMERGY (SEJs)
E	ENVIRONMENT				
E1	Atmosphere				
E2	Ecol. Prod.				
E3	Energy				
E4	Land				
E5	Water				
E6	Materials				
F	FUEL ENERGY				
F1	Equipment				
F2	Facilities				
F3	Materials				
G	GOODS				
G1	Equipment				
G2	Facilities				
G3	Materials				
G4	Tools				
S	SERVICES				
S1	Labor				
S2	Materials				

Table 4. Environmental value engineering EMERGY analysis input table (Roudebush, 1992).

Summary EMERGY analysis input table

The solar EMERGY values for both alternatives from the EMERGY analysis input tables described above were then input into the summary EMERGY data tables similar to Table 5

below. The table indicated the total EMERGY for both alternatives independently, meeting the comparison objective of this study.

CONSTRUCTION ALTERNATIVE	INPUTS IN SEJs				TOTALS SEJs
	ENVIRONMENT (E)	FUEL ENERGY (F)	GOODS (G)	SERVICES (S)	
A					
B					

Table 5. Environmental value engineering summary EMERGY table.

CHAPTER 4

FINDINGS

This chapter gives the results of the environmental value engineering assessment of horizontal directional drilling, alternative A, and open-cut construction, alternative B. Following the methodology in this research project, these results were realized.

Environmental value engineering EMERGY calculations

The environmental impact EMERGY quantities associated with the inputs of the environment, fuel energy, goods, and services were obtained from the calculations done in the spreadsheet provided in Appendices F and G for HDD and open-cut, respectively. These contain the raw units that were then input into the environmental value engineering EMERGY input tables in appendix E.

Environmental value engineering EMERGY analysis input tables

Information on the environmental value engineering EMERGY analysis input tables comes from four sources, one of which is specific to open-cut. First, the environmental impact EMERGY input source items were from the list given in Appendix A. Second, the raw units were obtained from the environmental value engineering EMERGY calculations described in the preceding chapter. Third, the transformities were obtained from the transformity list provided in Appendix D. Fourth, the transformities for the flexible pavement were obtained from the computation in Appendix H. These tables are provided for the phase under study, construction (F), for both competing alternatives. Samples of these tables follow.

HORIZONTAL DIRECTIONAL DRILLING (Alternative A)					
TABLE AF. Construction Phase EMERGY Input Table					
	Item	Section in Appendix E	Raw Units (g, J, \$, gal, lbs)	Transformity (SEJ/unit)	Solar EMERGY (SEJ)
E	ENVIRONMENT				2.40E+17
E1	Atmosphere				
E2	Ecol. Prod.Seed (lbs)	9	1.20	2.14E+12	2.56E+12
E3	Ecol. Prod.Fertilizer (lbs)	9	9.59	5.44E+12	5.22E+13
E4	Ecol. Prod. Top soil (lbs)	9	261000.00	7.76E+11	2.02E+17
E5	Ecol. Prod.Drilling fluid (gal)	3, 4, & 5	150477.17	2.52E+11	3.79E+16
E6	Energy				
E7	Land				
E8	Water (gal)	7	22375.76	2.76E+08	6.17E+12
E9	Materials. Limestone (lbs)	8	71214.33	7.35E+08	5.23E+13
F	FUEL ENERGY				2.46E+16
F1	Equipment (gal)	Grand Totals	2464.95	1.00E+13	2.46E+16
F2	Facilities				
F3	Materials				
G	GOODS				1.59E+15
G1	Equipment (lbs)	Grand Totals	523.78	3.04E+12	1.59E+15
G2	Facilities				
G3	Materials				
G4	Tools				
S	SERVICES				2.34E+16
S1	Labor (\$)	Grand Totals	21261.03	1.10E+12	2.34E+16
S2	Materials				

Table 6. EVE EMERGY analysis input table for alternative A, HDD.

OPEN-CUT (Alternative B)					
TABLE BF. Construction Phase EMERGY Input Table					
	Item	Section in Appendix E	Raw Units (g, J, \$, gal, lbs)	Transformity (SEJ/unit)	Solar EMERGY (SEJ)
E	ENVIRONMENT				5.43E+17
E1	Atmosphere				
E2	Ecol. Prod.Seed (lbs)	7	27.48	2.14E+12	5.87E+13
E3	Ecol. Prod.Fertilizer (lbs)	7	219.83	5.44E+12	1.20E+15
E4	Ecol. Prod. Top soil (lbs)	7	221666.67	7.76E+11	1.72E+17
E5	Land				
E6	Water (gal)	2	1968.00	2.76E+08	5.42E+11
E7	Materials. Limestone (lbs)	5	1820467.56	7.35E+08	1.34E+15
E8	Asphalt pvmnt system (SF)	7	2214.00	1.66E+14	3.68E+17
F	FUEL ENERGY				1.43E+17
F1	Equipment (gal)	Grand Totals	6625.78	1.00E+13	6.63E+16
F2	Facilities				
F3	Materials				
F4	Asphalt pvmnt system (SF)	7	2214.00	3.46E+13	7.65E+16
G	GOODS				7.74E+16
G1	Equipment (lbs)	Grand Totals	2251.81	3.04E+12	6.84E+15
G2	Facilities				
G3	Materials Aluminum (lbs)	4	88.20	7.26E+12	6.40E+14
G4	Asphalt pvmnt system (SF)	7	2214.00	3.16E+13	6.99E+16
S	SERVICES				1.08E+17
S1	Labor (\$)	Grand Totals	34114.21	1.10E+12	3.75E+16
S2	Materials				
S3	Asphalt pvmnt system (SF)	7	2214.00	3.19E+13	7.07E+16

Table 7. EVE EMERGY analysis input table for alternative B, Open-cut.

Figures 9 and 10 below are a graphical representation of the data in the Tables 6 and 7 above, respectively.

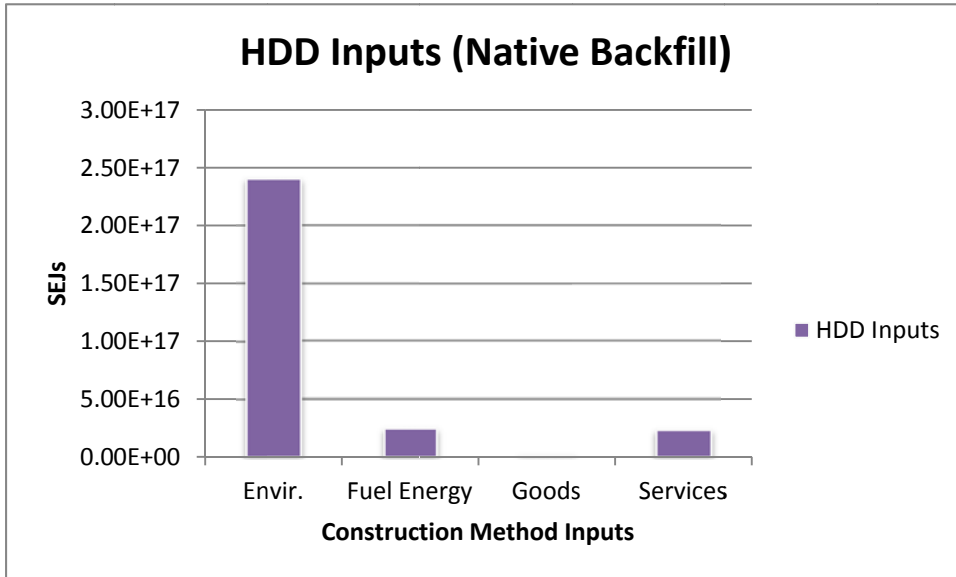

Figure 9. EVE EMERGY inputs for alternative A (HDD).

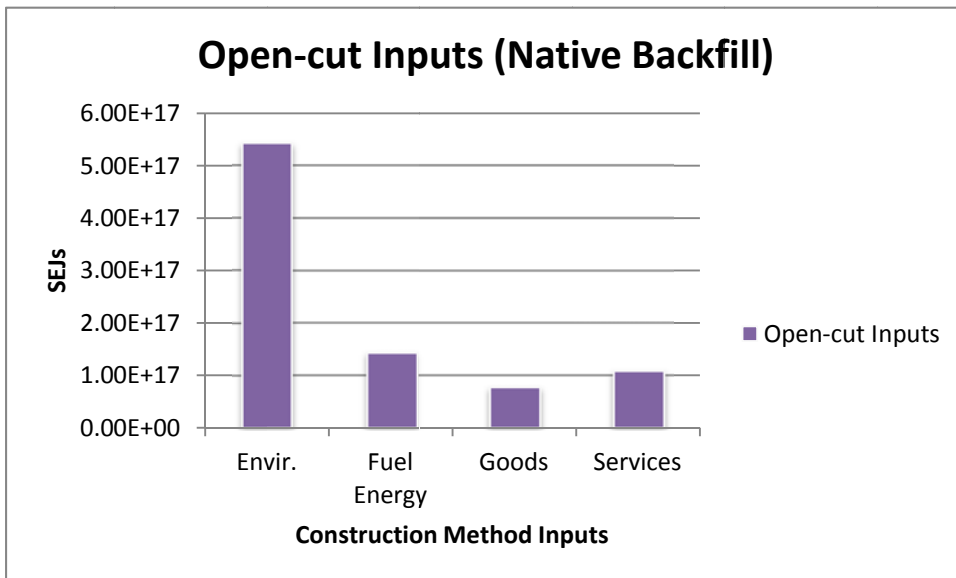

Figure 10. EVE EMERGY inputs for alternative B (Open-cut).

Environmental value engineering summary EMERGY input table

An environmental value engineering summary EMERGY input Table 8 represents the EMERGY of input sources for both alternatives during the construction phase (F). This table brings together the EMERGY input sources of environment (E), fuel energy (F), goods (G), and services (S) for both alternatives from the environmental value engineering EMERGY analysis input tables here above. These EMERGY input sources are given in columns across while the construction method alternative is represented by rows on the left column. Total EMERGY for the construction method alternative is given by the cells in the column to the farthest right.

CONSTRUCTION ALTERNATIVE		INPUTS IN SEJs				TOTALS SEJ
		ENVIRONMENT (E)	FUEL ENERGY (F)	GOODS (G)	SERVICES (S)	
A	HDD	2.40E+17	2.46E+16	1.59E+15	2.34E+16	2.90E+17
B	OPEN-CUT	5.43E+17	1.43E+17	7.74E+16	1.08E+17	8.71E+17

Table 8. Environmental value engineering summary EMERGY input table.

Comparison of the construction method alternatives

HDD Vs Open-cut (With Native Backfill)

Figure 11 below shows the comparison between the two construction method alternatives for the various inputs and the SEJs of the different inputs in their respective construction method alternatives. For alternative A, HDD, inputs from the environment (E), fuel energy (F), goods (G), and services (S) account for 83%, 8%, 1%, and 8% of the total EMERGY used up, respectively . For alternative B, open-cut, inputs from the environment (E), fuel energy (F),

goods (G), and services (S) account for 62%, 16%, 9%, and 12% of the total EMERGY used up, respectively (Table 13).

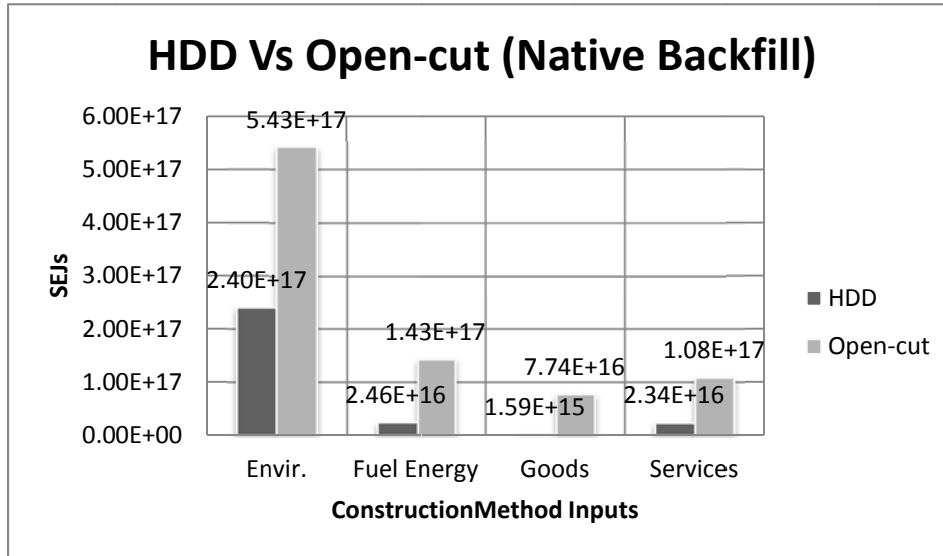

Figure 11. Comparison of the construction method alternatives.

Native backfill Vs Imported backfill

There is an increase in fuel energy inputs (F) when imported backfill is used. Although there is considerably less compaction with imported material, there is hauling of the excavated material off site and hauling of the foreign material to the site. In sum, this increases the fuel energy input (F) as shown in Table 9.

Native Backfill (SEJs)			Imported Backfill (SEJs)		
	Open-cut	HDD		Open-cut	HDD
Environment	5.43E+17	2.40E+17	Environment	5.49E+17	2.41E+17
Fuel Energy	1.43E+17	2.46E+16	Fuel Energy	1.44E+17	2.52E+16
Goods	7.74E+16	1.59E+15	Goods	7.65E+16	1.61E+15
Services	1.08E+17	2.34E+16	Services	1.08E+17	2.34E+16
Totals	8.71E+17	2.90E+17	Totals	8.79E+17	2.91E+17

Table 9. Native backfill Vs Imported backfill.

Graphical representations of this comparison for both open-cut and horizontal directional drilling follow is presented in Figures 12 and 13, respectively.

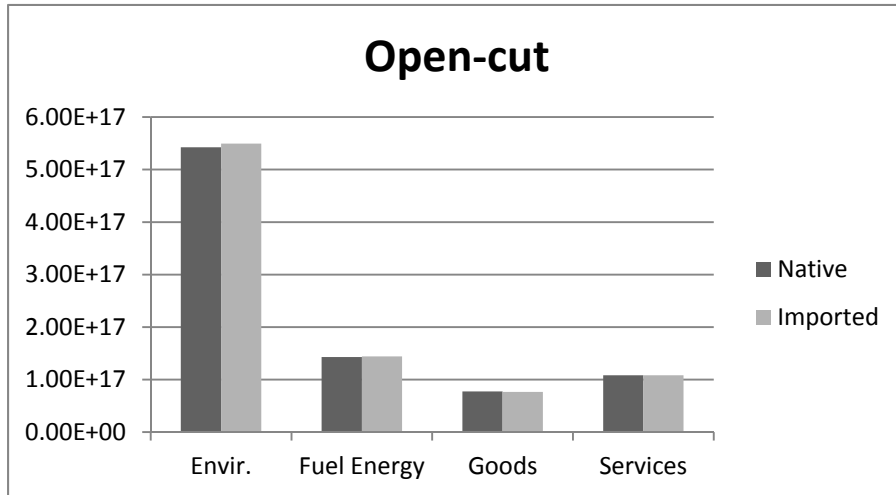

Figure 12. Native backfill Vs Imported backfill (Open-Cut).

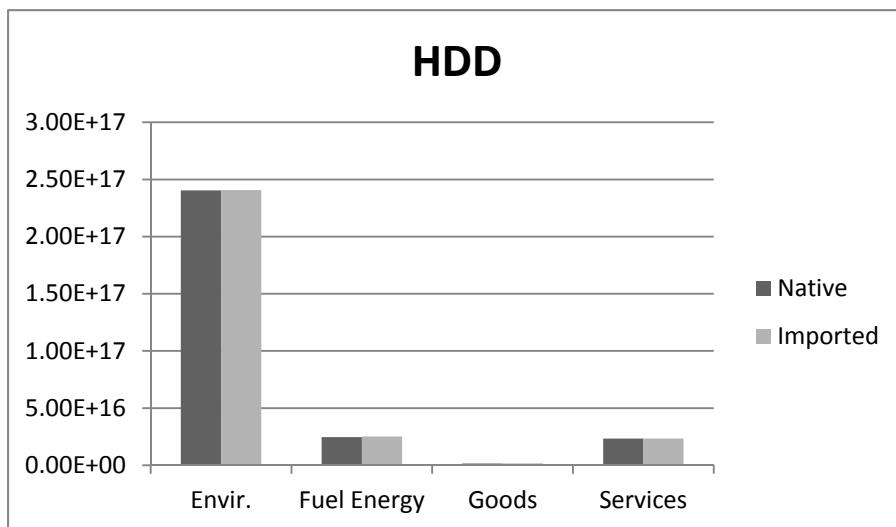

Figure 13. Native backfill Vs Imported backfill (HDD).

Paved Vs Unpaved

If the ground surface is not paved (i.e. the pipe is laid in an unpaved area), there is a significant reduction in all inputs of environment (E), fuel energy (F), goods (G), and services (S) for the open-cut construction method. This reduction of 65% can be attributed to the elimination of environment, fuel energy, goods, and services inputs due to elimination of pavement restoration as shown in Table 10. Most significant reduction is the environmental inputs which are the highest in flexible pavement restoration. Water used in the pavement saw cutting process also adds to this reduction in the environmental inputs (E)

Open-cut (Paved)			Open-cut (Unpaved)		
	SEJs	%		SEJs	%
Environment	5.43E+17	62%	Environment	1.92E+17	63%
Fuel Energy	1.43E+17	16%	Fuel Energy	6.68E+16	22%
Services	1.08E+17	12%	Services	3.71E+16	12%
Goods	7.74E+16	9%	Goods	7.54E+15	2%
Totals	8.71E+17	100%	Totals	3.04E+17	100%

Table 10. Paved Vs Unpaved.

The graphical representation of this comparison for open-cut follows in Figures 14

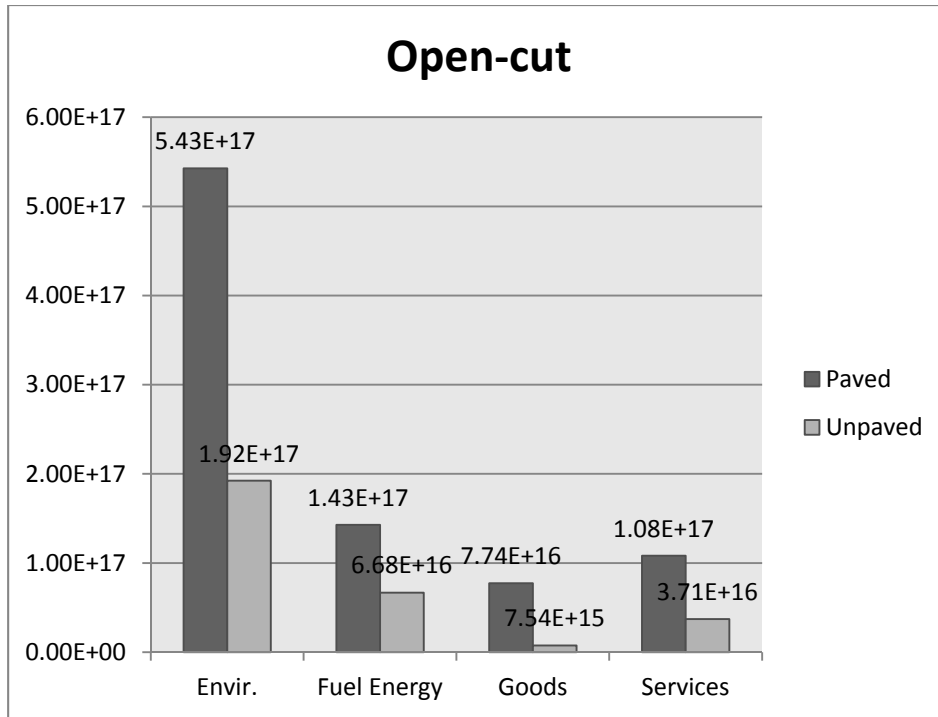

Figure 14. Paved Vs Unpaved.

Sensitivity to depth

From the tables 11 and 12 and the accompanying Figure 15, it is evident that open-cut construction method is more sensitive to change in depth when compared to horizontal directional drilling. This can be attributed to the significant change in volumes of excavation and backfill involved in the open-cut construction method.

HDD	Depth (Feet)				
	4	5	6	7	8
TOTAL SEJs	2.86E+17	2.88E+17	2.90E+17	2.92E+17	2.94E+17

Table 11. Sensitivity to depth (HDD).

Open-cut	Depth (Feet)				
	4	5	6	7	8
TOTAL SEJs	8.48E+17	8.59E+17	8.71E+17	8.83E+17	8.94E+17

Table 12. Sensitivity to depth (Open-cut).

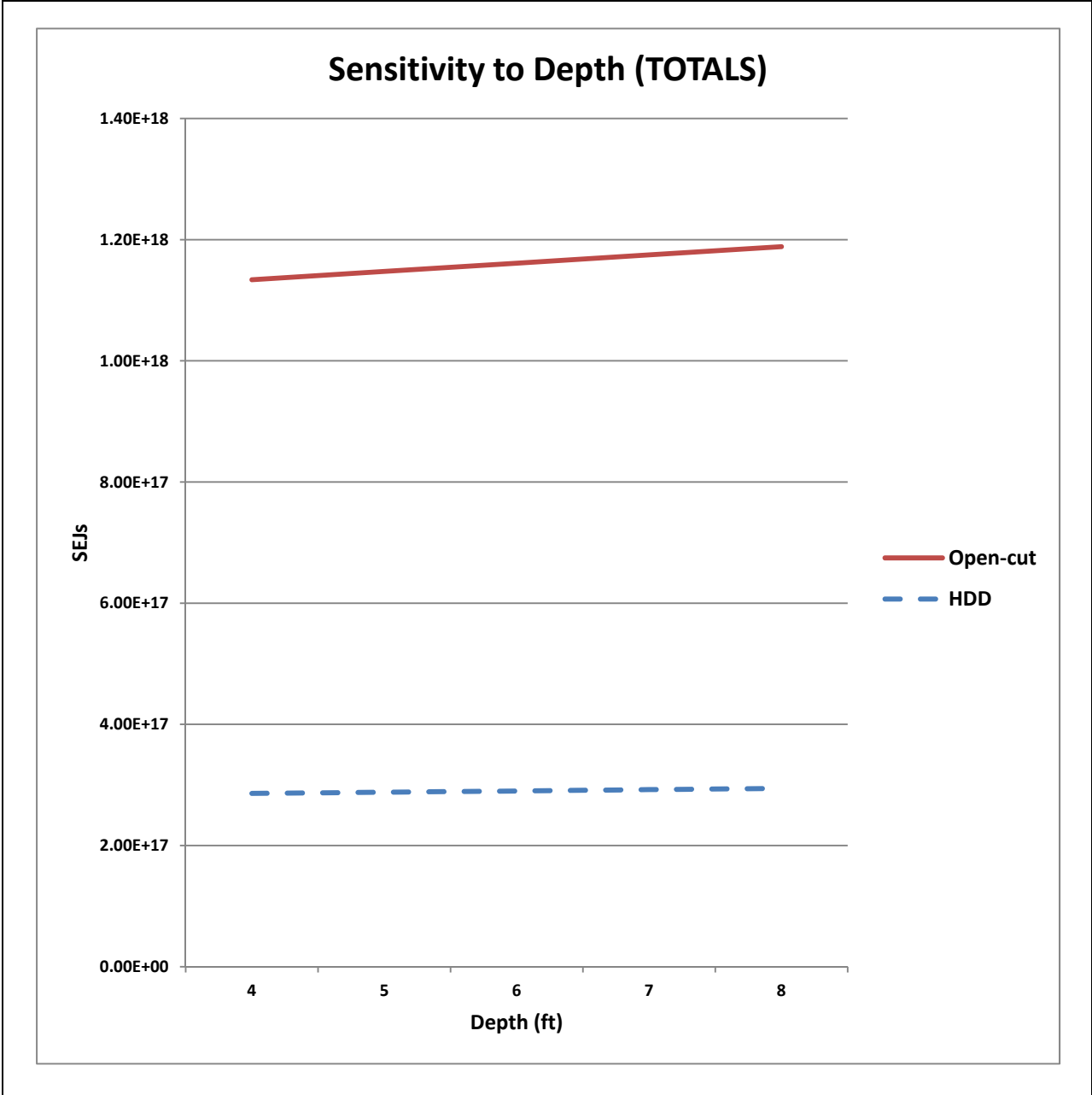

Figure 15. Sensitivity to change in depth.

Discussion

Table 13 ranks the EMERGY inputs from the highest to the lowest for both alternatives, independently, in the construction phase (F).

EMERGY INPUTS	HDD		Open-cut	
	SEJs	%	SEJs	%
Environment (E)	2.40E+17	83%	5.43E+17	62%
Fuel Energy (F)	2.46E+16	8%	1.43E+17	16%
Services (S)	2.34E+16	8%	1.08E+17	12%
Goods (G)	1.59E+15	1%	7.74E+16	9%
TOTALS	2.90E+17		8.71E+17	

Table 13. Ranking of EMERGY inputs.

- For both alternatives, environmental inputs (E) ranked highest. For alternative A (HDD), the 83% environmental input can be mainly attributed to the imported backfill (limestone) to connections and accessories, and the drilling fluid used in the process. 96.14% of the drilling fluid is water, which is a purely environmental input. Water is also used in the pipeline during the pullback process to counterbalance the buoyancy effect resultant from the fluid in the bore. Use of a pipe material, like ductile iron, that is heavier than HDPE can eliminate the need for water in the pipeline but there are other factors that must come to play in order to make an all inclusive decision on the pipe material to use.
- Open-cut construction method, on the other hand, has 62% environmental inputs. The reason for this high numbers can be mainly attributed to the imported backfill (limestone) to connections, accessories and bedding material, and environmental inputs required for the flexible pavement restoration. The large restoration area demands more seed and fertilizer which is a contributor to the higher quantity of environmental inputs. Fertilizer can be considered a petroleum product, but was included in this research project as an environmental input.
- It may be important to attain a balance in the inputs of the environment (E), fuel energy (F) goods (G), and services (S) in order to optimize inputs of resources. For both

alternatives, there is a need to explore alternatives that can reduce the environmental inputs (E) and increase the goods (G) toward resource optimization.

- The fuel energy inputs (F) for alternative A (HDD), though high in percentage, are considerably lower than those of open-cut. This is also the same for the services(S). This is mainly a factor of the large volumes involved that translates to longer project duration, and the larger labor force required for alternative B (open-cut).

CHAPTER 5

SUMMARY AND CONCLUSION

Summary

Traditionally, selection of a construction method for underground utility installation has been a factor of the 'dollar cost' considering that these choices are made within the constraints of fiscal conditions. Selection of a method is based on the lowest first cost often times not even considering the life cycle cost. Due to the demand from the consumers for products that are environmentally friendly beyond being functional and cost effective, there is a shift of focus to methodologies that can help evaluate the impact and contribution to the environment of competing alternatives. This research project employed the use of environmental value engineering to carry out the environmental life cycle assessment of horizontal directional drilling and open-cut construction methods.

A simulation of a water main installation along a street in a typical small or medium sized city in the United States was used in this analysis with both construction methods being applied to this model. The analysis carried out indicated that horizontal directional drilling has substantially less impact on the environment than open-cut construction method.

Conclusion

It was the purpose of this study to compare the environmental impact of both horizontal directional drilling (HDD) and open-cut construction methods using an environmental life cycle assessment methodology called environmental value engineering (EVE). Following an extensive

literature review, an assessment was carried out following the process enumerated in the methodology section of this report.

An assessment conclusion can be made, based on the results that are in the findings section of this report, that open-cut construction method has an impact of 66.69% greater than that of horizontal directional drilling on the environment, making HDD more environmentally friendly.

Future research

At the heart of environmental value engineering is the goal of providing a methodology that more accurately compares the environmental impact and contribution of alternatives competing for similar resource inputs. In this pursuit, one must include as many input requirements and related environmental impacts as possible. In this study, some environmental value engineering life cycle phases were excluded because they were deemed to be similar for both alternatives. Other inputs were also not considered for the same reason. Future research should focus on improving on the efforts made on earlier research in this area. The following are the areas need to be focused on in future research:

- Developing transformities for construction related assemblies and sub-assemblies.
- Developing transformities that are sensitive to the machining process that goes into the production of different pieces of equipment. This will help differentiate a complex, highly machined, and technologically advanced piece of equipment from a basic one.
- Conducting an environmental value engineering EMERGY analysis of high density polyethylene (HDPE) versus polyvinylchloride (PVC) and, possibly, other materials that are oftentimes employed in underground utility construction.

- An EVE EMERGY analysis of the energy used up following traffic disruptions during both trench and trenchless operations.
- Developing more distinctions between inputs of environment (nature made), fuel energy, goods (human made), and services for future environmental value engineering applications.
- Application of EVE to compare systems of transportation, education, housing, etc.

REFERENCES

- Gangavarapu, S. B., Najafi, M., & Salem, O. (2004). *Quantitative analysis and comparison of traffic disruption using open-cut and trenchless methods of pipe installation*. Paper presented at the North American Society for Trenchless Technology (NASTT) NO DIG conference. New Orleans, Louisiana
- HDD Consortium. (2004) Horizontal directional drilling good practices guidelines. Arlington, Virginia
- Kariuki, J.G. (2009). *Cost comparison between horizontal directional drilling and open cut construction method in Nairobi, Kenya*. Bowling Green State University, Ohio.
- Odum, H.T. (1988). *Self-organization, transformity, and information*. American Association for the Advancement of Science weekly journal. Science, Volume 242, pp. 1132-1139
- Odum, H.T. (1998). *Emergy Evaluation*. Paper presented at the international workshop on advances in energy studies: energy flows in ecology and economy, Porto Venere, Italy
- Odum, H.T. (2000). Emergy evaluation of an OTEC electrical power system. *Energy*, 25(4), 389-393.
- Odum, H.T., & Odum, E.C. (2006). The prosperous way down. *Energy*, 31(1), 21-32.
- Peurifoy, R.L., & Oberlender, G.D. (2002). *Estimating construction costs*. McGraw-Hill, Inc.
- Rehan, R., & Knight, M. (2007). *Do trenchless pipeline construction Methods Reduce Greenhouse Gas Emission?* University of Waterloo, Ontario.

Roudebush, W.H. (1992). *Environmental value engineering (EVE): A system for analyzing the environmental impact of built environment alternatives*. (Doctoral dissertation, University of Florida, 1992). University Microfilms International, Ann Arbor, MI.

Roudebush, W.H. (1997). *Environmental value engineering (EVE): Environmental life cycle assessment of concrete and asphalt highway pavement systems*. Portland Cement Association.

Roudebush, W.H. (2003). *Environmental value engineering: An environmental life cycle assessment methodology for comparing built environment alternatives*. Paper presented at the American Society for Engineering Education annual conference and exposition

Shafiee, S., & Topal, E. (2009). *When will fossil fuel reserves be diminished?* *Energy Policy*, 37(1), 181-189. doi:10.1016/j.enpol.2008.08.016

Woodroffe, N. J. A., & Ariaratnam, S.T. (2008). *Cost and risk evaluation of horizontal directional drilling versus open cut in an urban environment*. *Practice periodical on structural design and construction* (May, 2008)

APPENDICES

APPENDIX A: ENVIRONMENTAL IMPACT EMERGY INPUT SOURCES

PHASE F. Construction

E. Environment (Renewable):

E1. Atmosphere

E2. Ecological Production

- Seed
- Fertilizer
- Soil

E3. Energy

- Sun
- Earth

E4. Land

- Area
- Resources

E5. Water

- Area
- Resources

F. Fuel Energy (non renewable):

F1. Equipment

F2. Facilities

F3. Materials

G. Goods:

G1. Equipment

G2. Facilities

G3. Materials

G4. Tools

S. Services:

S1. Labor

S2. Materials

APPENDIX B: PIPELINE AND TYPICAL CITY STREET: PLAN

Pipeline Profile

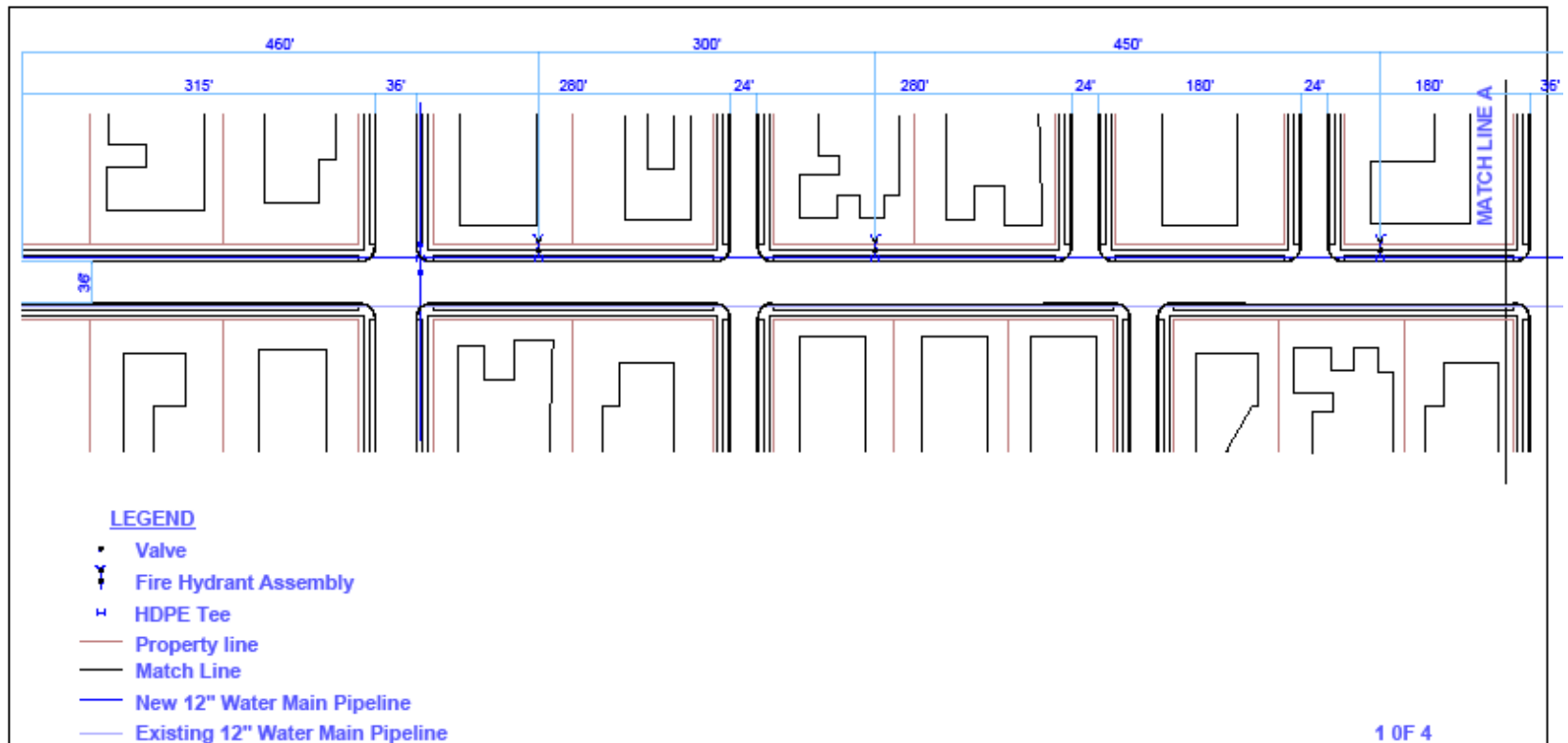

Pipeline Profile

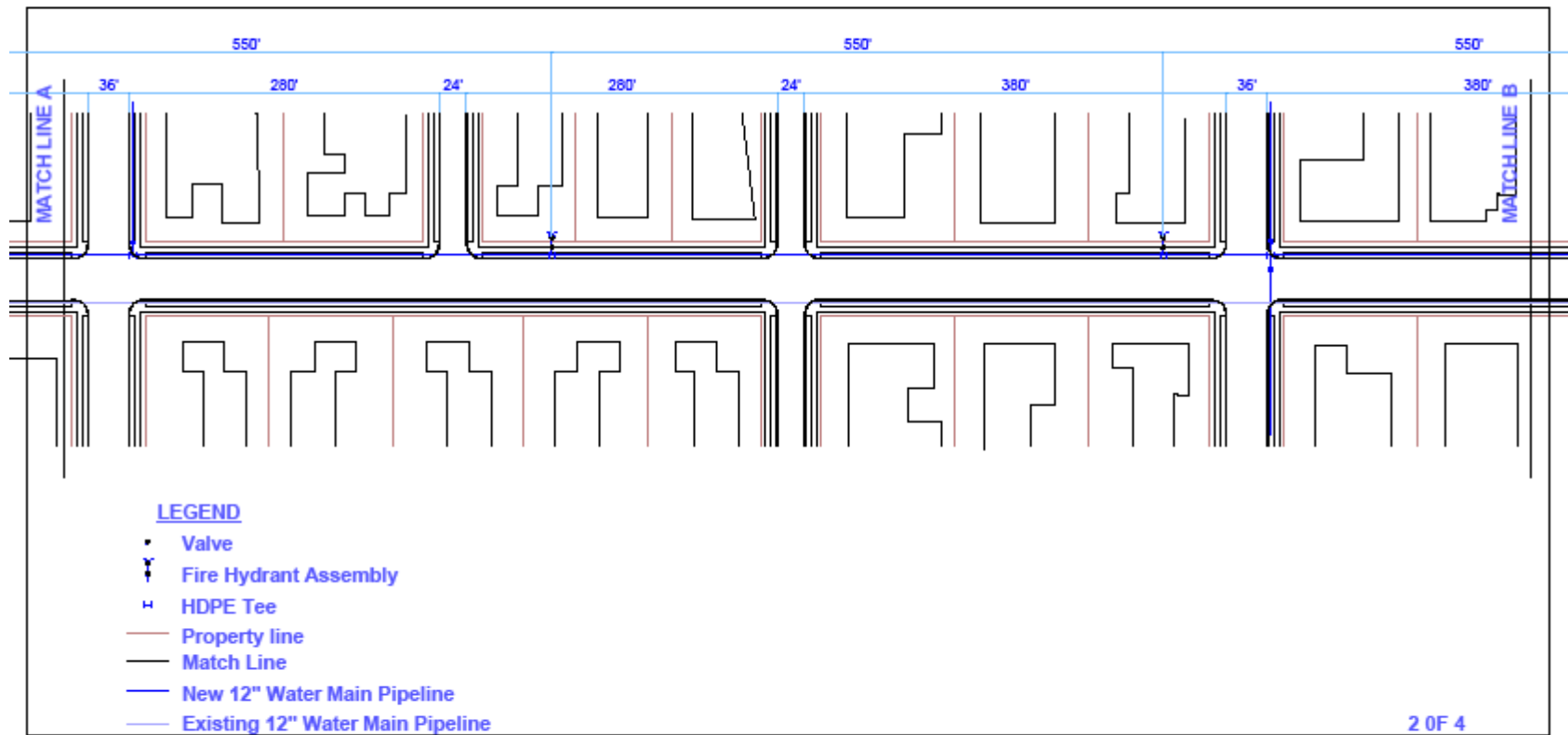

Pipeline Profile

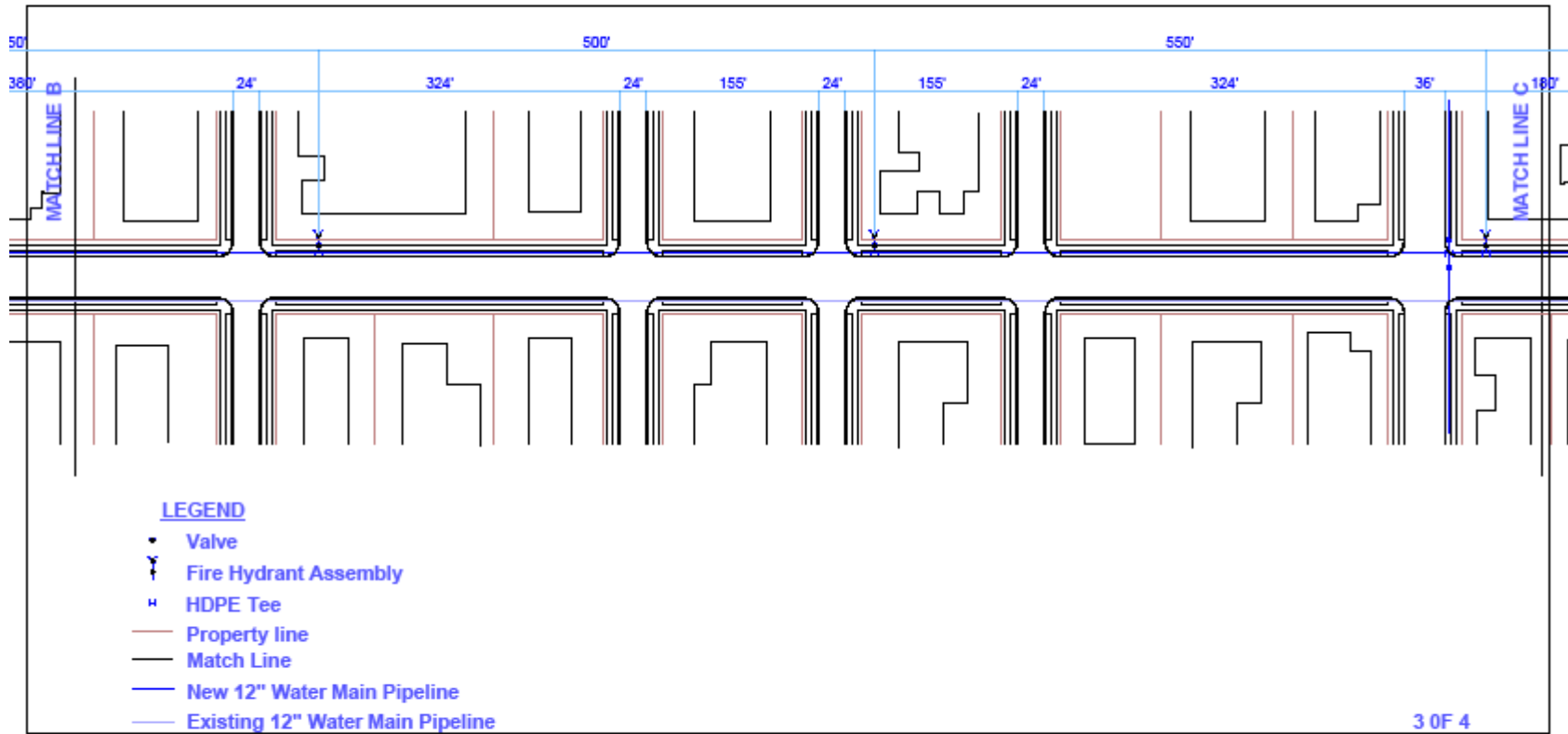

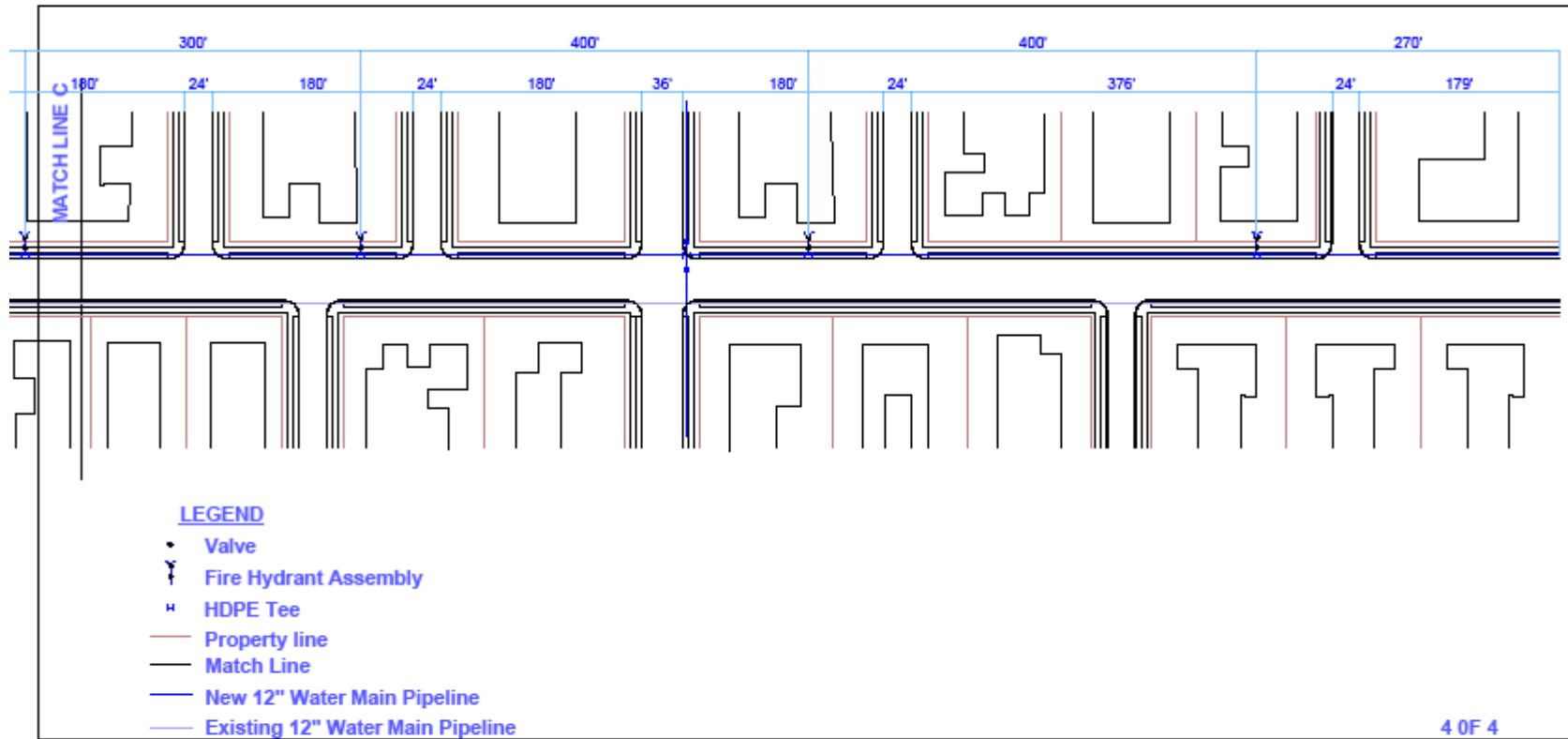

Pipeline Profile

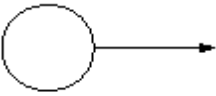
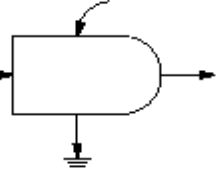
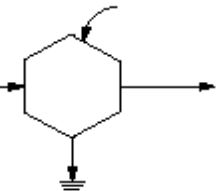
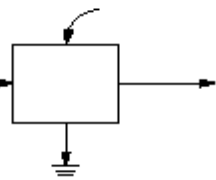
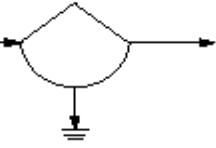

APPENDIX C: ENERGY SYSTEMS DIAGRAM SYMBOLS AND LANGUAGE

Energy systems diagram symbols and language (Roudebush, 1992).

SYMBOL	NAME	DESCRIPTION
	Energy Circuit	A pathway whose flow is proportional to the quantity in the storage or source upstream
	Energy Circuit	Outside source of energy delivering forces according to a program controlled from outside; a forcing function
	Producer	Unit that collects and transforms low-quality energy under control interactions of high quality flows
	Consumer	Unit that transforms energy quality, stores it, and feeds it back autocatalytically to improve inflow
	Box	Miscellaneous symbol to use for whatever subsystem, unit or function labeled.
	Tank	A compartment of energy storage within the system storing a quantity as the balance of inflows and outflows; a state variable
	Heat Sink	Dispersion of potential energy into heat that accompanies all real transformation processes and storages; loss of potential energy from further use by the system.
	Transaction	A unit that indicates a sale of goods or services (solid line) in exchange for payment of money (dashed line).

APPENDIX D: TRANSFORMITIES

<u>TRANSFORMITIES FOR ENERGIES, RESOURCES, AND COMMODITIES</u>					
(Refer to notes 1 and 2 unless otherwise noted)					
MATERIAL	UNIT	TRANSFORMITIES	UNIT	TRANSFORMITIES	
Aluminum ingots	(g)	1.60E+10	(lbs)	7.26E+12	
Asphalt	(J)	3.47E+05			
Asphalt Concrete	(g)	1.78E+09	(lbs)	8.07E+11	
Cement	(g)	3.30E+10	(lbs)	1.50E+13	
Clay	(g)	1.71E+09	(lbs)	7.76E+11	
Coal	(J)	3.98E+04			
Concrete	(g)	9.99E+08	(lbs)	4.53E+11	
Copper	(g)	6.80E+10	(lbs)	3.08E+13	
Drilling Fluid	(lbs)	3.02E+10	(gal)	2.52E+11	(Refer to note 4)
Electricity	(J)	1.59E+05			
Fertilizer	(g)	1.20E+10	(lbs)	5.44E+12	
Grain	(J)	6.80E+04			
Iron	(g)	1.80E+09	(lbs)	8.16E+11	
Limestone	(g)	1.62E+06	(lbs)	7.35E+08	
Machinery	(g)	6.70E+09	(lbs)	3.04E+12	
Mulch	(g)	1.71E+09	(lbs)	7.76E+11	
Natural gas	(J)	4.80E+04			
Oil	(J)	5.30E+04			
Paper	(J)	2.15E+05			
Petroleum product	(J)	6.60E+04	(gal)	1.00E+13	
Plastic	(g)	3.20E+09	(lbs)	1.45E+12	
Polymers	(g)	3.20E+09	(lbs)	1.45E+12	
Rubber	(g)	4.30E+09	(lbs)	1.95E+12	
Soda Ash	(g)	1.62E+06	(lbs)	7.35E+08	
Seed	(g)	4.71E+09	(lbs)	2.14E+12	
Service, labor	(\$)	1.10E+12	(\$)	1.10E+12	(Refer to note 3)
Steel	(g)	1.80E+09	(lbs)	8.16E+11	
Stone, mined	(g)	1.00E+09	(lbs)	4.54E+11	
Stone, natural state	(g)	8.50E+08	(lbs)	3.86E+11	
Topsoil	(g)	1.71E+09	(lbs)	7.76E+11	
Water	(g)	7.28E+04	(gal)	2.76E+08	
Wood	(J)	3.49E+04			

NOTES:

1. Transformity units are solar emjoules/Joule, solar emjoules/gram, solar emjoules/ gal, solar emjoules/ lb, or solar emjoules/US \$
2. Source: Dr. Howard T. Odum, Department of Environmental Engineering Sciences, University of Florida, Gainesville, Florida.
3. Units in 1998 U.S. dollars.
4. The transformity for the drilling fluid is specific to this mix ratios {See Appendix F}

APPENDIX E: EVE EMERGY ANALYSIS INPUT TABLES

Native Backfill

HORIZONTAL DIRECTIONAL DRILLING (Alternative A)					
TABLE AF. Construction Phase EMERGY Input Table					
	Item	Section in Appendix E	Raw Units (g, J, \$, gal, lbs)	Transformity (SEJ/unit)	Solar EMERGY (SEJ)
E	ENVIRONMENT				2.40E+17
E1	Atmosphere				
E2	Ecol. Prod.Seed (lbs)	9	1.20	2.14E+12	2.56E+12
E3	Ecol. Prod.Fertilizer (lbs)	9	9.59	5.44E+12	5.22E+13
E4	Ecol. Prod. Top soil (lbs)	9	261000.00	7.76E+11	2.02E+17
E5	Ecol. Prod.Drilling fluid (gal)	3, 4, & 5	150477.17	2.52E+11	3.79E+16
E6	Energy				
E7	Land				
E8	Water (gal)	7	22375.76	2.76E+08	6.17E+12
E9	Materials. Limestone (lbs)	8	71214.33	7.35E+08	5.23E+13
F	FUEL ENERGY				2.46E+16
F1	Equipment (gal)	Grand Totals	2464.95	1.00E+13	2.46E+16
F2	Facilities				
F3	Materials				
G	GOODS				1.59E+15
G1	Equipment (lbs)	Grand Totals	523.78	3.04E+12	1.59E+15
G2	Facilities				
G3	Materials				
G4	Tools				
S	SERVICES				2.34E+16
S1	Labor (\$)	Grand Totals	21261.03	1.10E+12	2.34E+16
S2	Materials				

Native Backfill

OPEN-CUT (Alternative B)					
TABLE BF. Construction Phase EMERGY Input Table					
	Item	Section in Appendix E	Raw Units (g, J, \$, gal, lbs)	Transformity (SEJ/unit)	Solar EMERGY (SEJ)
E	ENVIRONMENT				5.43E+17
E1	Atmosphere				
E2	Ecol. Prod.Seed (lbs)	7	27.48	2.14E+12	5.87E+13
E3	Ecol. Prod.Fertilizer (lbs)	7	219.83	5.44E+12	1.20E+15
E4	Ecol. Prod. Top soil (lbs)	7	221666.67	7.76E+11	1.72E+17
E5	Land				
E6	Water (gal)	2	1968.00	2.76E+08	5.42E+11
E7	Materials. Limestone (lbs)	5	1820467.56	7.35E+08	1.34E+15
E8	Asphalt pvmnt system (SF)	7	2214.00	1.66E+14	3.68E+17
F	FUEL ENERGY				1.43E+17
F1	Equipment (gal)	Grand Totals	6625.78	1.00E+13	6.63E+16
F2	Facilities				
F3	Materials				
F4	Asphalt pvmnt system (SF)	7	2214.00	3.46E+13	7.65E+16
G	GOODS				7.74E+16
G1	Equipment (lbs)	Grand Totals	2251.81	3.04E+12	6.84E+15
G2	Facilities				
G3	Materials Aluminum (lbs)	4	88.20	7.26E+12	6.40E+14
G4	Asphalt pvmnt system (SF)	7	2214.00	3.16E+13	6.99E+16
G5	Tools				
S	SERVICES				1.08E+17
S1	Labor (\$)	Grand Totals	34114.21	1.10E+12	3.75E+16
S2	Materials				
S3	Asphalt pvmnt system (SF)	7	2214.00	3.19E+13	7.07E+16

Imported Backfill

HORIZONTAL DIRECTIONAL DRILLING (Alternative A)					
TABLE AF. Construction Phase EMERGY Input Table					
	Item	Section in Appendix E	Raw Units (g, J, \$, gal, lbs)	Transformity (SEJ/unit)	Solar EMERGY (SEJ)
E	ENVIRONMENT				2.41E+17
E1	Atmosphere				
E2	Ecol. Prod.Seed (lbs)	9	1.20	2.14E+12	2.56E+12
E3	Ecol. Prod.Fertilizer (lbs)	9	9.59	5.44E+12	5.22E+13
E4	Ecol. Prod. Top soil (lbs)	9	261000.00	7.76E+11	2.02E+17
E5	Ecol. Prod.Drilling fluid (gal)	3, 4, & 5	150477.17	2.52E+11	3.79E+16
E6	Energy				
E7	Land				
E8	Water (gal)	7	22375.76	2.76E+08	6.17E+12
E9	Materials. Limestone (lbs)	8	403547.89	7.35E+08	2.97E+14
F	FUEL ENERGY				2.52E+16
F1	Equipment (gal)	Grand Totals	2522.42	1.00E+13	2.52E+16
F2	Facilities				
F3	Materials				
G	GOODS				1.61E+15
G1	Equipment (lbs)	Grand Totals	529.44	3.04E+12	1.61E+15
G2	Facilities				
G3	Materials				
G4	Tools				
S	SERVICES				2.34E+16
S1	Labor (\$)	Grand Totals	21261.03	1.10E+12	2.34E+16
S2	Materials				

Imported Backfill

OPEN-CUT (Alternative B)					
TABLE BF. Construction Phase EMERGY Input Table					
	Item	Section in Appendix E	Raw Units (g, J, \$, gal, lbs)	Transformity (SEJ/unit)	Solar EMERGY (SEJ)
E	ENVIRONMENT				5.49E+17
E1	Atmosphere				
E2	Ecol. Prod.Seed (lbs)	7	27.48	2.14E+12	5.87E+13
E3	Ecol. Prod.Fertilizer (lbs)	7	219.83	5.44E+12	1.20E+15
E4	Ecol. Prod. Top soil (lbs)	7	221666.67	7.76E+11	1.72E+17
E5	Energy				
E6	Land				
E7	Water (gal)	2	1968.00	2.76E+08	5.42E+11
E8	Materials. Limestone (lbs)	5	11137607.95	7.35E+08	8.18E+15
E9	Asphalt pvmnt system (SF)	7	2214.00	1.66E+14	3.68E+17
F	FUEL ENERGY				1.44E+17
F1	Equipment (gal)	Grand Totals	6776.08	1.00E+13	6.78E+16
F2	Facilities				
F3	Materials				
F4	Asphalt pvmnt system (SF)	7	2214.00	3.46E+13	7.65E+16
G	GOODS				7.65E+16
G1	Equipment (lbs)	Grand Totals	1970.48	3.04E+12	5.99E+15
G2	Facilities				
G3	Materials Aluminum (lbs)	4	88.20	7.26E+12	6.40E+14
G4	Asphalt pvmnt system (SF)	7	2214.00	3.16E+13	6.99E+16
S	SERVICES				1.08E+17
S1	Labor (\$)	Grand Totals	34114.21	1.10E+12	3.75E+16
S2	Materials				
S3	Asphalt pvmnt system (SF)	7	2214.00	3.19E+13	7.07E+16

Unpaved

OPEN-CUT (Alternative B)					
TABLE BF. Construction Phase EMERGY Input Table					
	Item	Section in Appendix E	Raw Units (g, J, \$, gal, lbs)	Transformity (SEJ/unit)	Solar EMERGY (SEJ)
E	ENVIRONMENT				1.92E+17
E1	Atmosphere				
E2	Ecol. Prod.Seed (lbs)	7	30.30	2.14E+12	6.47E+13
E3	Ecol. Prod.Fertilizer (lbs)	7	242.42	5.44E+12	1.32E+15
E4	Ecol. Prod. Top soil (lbs)	7	244444.44	7.76E+11	1.90E+17
E5	Energy				
E6	Land				
E7	Water (gal)	2	0.00	2.76E+08	0.00E+00
E8	Materials. Limestone (lbs)	5	1820467.56	7.35E+08	1.34E+15
E9	Asphalt pvmnt system (SF)	7	0.00	1.66E+14	0.00E+00
F	FUEL ENERGY				6.68E+16
F1	Equipment (gal)	Grand Totals	6679.52	1.00E+13	6.68E+16
F2	Facilities				
F3	Materials				
F4	Asphalt pvmnt system (SF)	7	0.00	3.46E+13	0.00E+00
G	GOODS				7.54E+15
G1	Equipment (lbs)	Grand Totals	2271.57	3.04E+12	6.90E+15
G2	Facilities				
G3	Materials Aluminum (lbs)	4	88.20	7.26E+12	6.40E+14
G4	Asphalt pvmnt system (SF)	7	0.00	3.16E+13	0.00E+00
S	SERVICES				3.71E+16
S1	Labor	Grand Totals	33749.58	1.10E+12	3.71E+16
S2	Materials				
S3	Asphalt pvmnt system (SF)	7	0.00	3.19E+13	0.00E+00

APPENDIX F: ALTERNATIVE A CALCULATIONS (HDD)

HDD CALCULATIONS (Native Backfill)

HORIZONTAL DIRECTIONAL DRILLING (ALTERATIVE A) - NATIVE BACKFILL							
STEPS	UNIT	QTTY	EQUIPMENT			LABOR	OTHER
			F-gal	G-lbs	S-\$	S-\$	
Mobilization							
Equipment Setup							
Pilot bore and tracking							
Reaming 12 inch							
Reaming 18 inch							
Pipe layout and fusion							
Pullback							
Connection							
Restoration and Clean-up							
Demobilization							
Equipment							
Labor							
1. MOBILIZATION							
Delivering Rig, downhole tools and pipe pulling devices on site	hrs	3.83	60.03	5.07	\$88.17		
Delivering mixing system on site	hrs	1.67	26.10	9.15			
Delivering backhoe loader on site	hrs	3.83	60.03	5.07	\$88.17		
Delivering fusion machine on site	hrs	3.83	60.03	5.07	\$88.17		
Delivering vac truck on site	hrs	1.67	39.17	7.21			
Delivering Dump truck on site	hrs	1.67	26.10	2.57			
Loading and off loading	hrs	0.50					
Hauling at 45 mph + Trip Back to Yard	hrs	3.33					
TOTAL		2.17				\$281.67	

HORIZONTAL DIRECTIONAL DRILLING (ALTERNATIVE A) - NATIVE BACKFILL Contd.							
	UNIT	QTTY	EQUIPMENT			LABOR	OTHER
			F-gal	G-lbs	S-\$	S-\$	
2. EQUIPMENT SETUP							
Positioning of the rig over the borehole centerline							
Stake-down of the rig							
Setup of all other equipment and materials							
Delineation of the entry and exit areas							
TOTAL	{Estimate}	hrs	1.00			\$130.00	
BORING							
Bores	No	12.00					
Pilot hole diameter	In	6.00					
Pre-reamed hole diameter	In	12.00					
Reamed hole diameter	In	18.00					
Drilling Fluid Viscosity	Sec/quar t	50.00					
Water Viscosity = 26 Seconds/quart	Sec/quar t	26.00					
Formation Flow Factor {Mixed soil conditions- medium consistency}		3.00					
Pump Rated capacity = 70 gpm	gpm	70.00					
Pump efficiency		0.76					
Drill rod	ft	10.00					
Conection and disconnection of rods	Sec	15.00					
Factor for locating drill head communicating and correction	{Estimate}	1.50					
Management Factor	{Estimate}	1.20					
Site Factor	{Estimate}	1.20					

HORIZONTAL DIRECTIONAL DRILLING (ALTERNATIVE A) - NATIVE BACKFILL Contd.

	UNIT	QTTY	EQUIPMENT			LABOR	OTHER
			F-gal	G-lbs	S-\$	S-\$	
3. PILOT BORE AND TRACKING							
Fluid vol	gal/ft	4.32					15047.71704
Maximum Drilling rate, <i>t</i>	sec/ft	13.76	131.56	35.47		\$1,731.29	
TOTAL							
4. REAMING 12 In.							
Fluid vol	gal/ft	17.28					60190.86816
Maximum Reaming rate, <i>t</i>	sec/ft	30.22	288.90	77.89		\$3,801.69	
TOTAL							
5. REAMING 18 In.							
Fluid vol	gal/ft	21.60					75238.5852
Maximum Reaming rate, <i>t</i>	sec/ft	37.24	355.96	95.97		\$4,684.18	
TOTAL							150477.1704
6. PIPE LAYOUT AND FUSION							
Wall thickness of 12 inch HDPE DR 11pipe (160 psi)	in	1.20					
Securing, facing, aligning, melting and joining	{Estimate} min	4.00					
Cooling under a pressure of 60 to 90 psi; at 90 sec/in.	{Estimate} sec	129.60					
Total per joint	sec	369.60					
TOTAL Fusion time	hrs	19.96	12.47	5.41		\$2,594.59	

HORIZONTAL DIRECTIONAL DRILLING (ALTERATIVE A) - NATIVE BACKFILL Contd.							
	UNIT	QTTY	EQUIPMENT			LABOR	OTHER
			F-gal	G-lbs	S-\$	S-\$	
7. PULLBACK							
Water to reduce bouyancy effect	gal/ft	4.24					22375.76
At 200 LF/hr	sec/ft	25.92	228.08	61.49		\$3,001.41	
Displaced mud (20% percolates in formation)	gal/ft	17.28	542.56	99.90			
Dump displaced mud 5 miles off site @35 mph {Estimate}	hrs/ trip	0.29	184.27	33.93			
TOTAL							
8. CONNECTIONS							
Excavation for fire hydrant assemblies: 3 ft x 6 ft {25% Swell factor}	CY	59.58					
Production 20 CY/ hr {Estimate}	hrs	2.98	15.56	4.99		\$387.29	
Excavation for tees and gate valves: 3 ft x 6 ft {25% Swell factor}	CY	27.08					
Production 20 CY/ hr {Estimate}	hrs	1.35	5.22	2.27		\$176.04	
Excavation for bore connections: 3 ft x 6 ft{25% Swell factor}	CY	70.42					
Production 20 CY/ hr {Estimate}	hrs	3.52	18.39	5.90		\$457.71	
Hauling of excavated material 5 miles off site @35 mph {Estimate}	hrs/ trip	0.29	6.04	0.60			
Backfill for fire hydrant assemblies: 3 ft x 6 ft Bedding{10% Shrinkage factor}	CY	10.19					27012.33
Backfill for tees and gate valves: 3 ft x 6 ft Bedding {10% Shrinkage factor}	CY	4.63					12278.33
Backfill for bore connections: 3 ft x 6 ft Bedding {10% Shrinkage factor}	CY	12.05					31923.67
Hauling fill material to site from 5 miles off site @35 mph Bedding {Estimate}	hrs/trip	0.29	6.04	0.60			
Placing 1.5 min/ layer (10 layers + 2 layers of 6" Bedding) {Estimate}	hrs	8.70	45.44	14.58		\$1,131.00	
Compaction 5 passes in 6 Inch lifts to 95% Proctor Density (AASHTO T99)	SF	31320.00					
Compaction at 40ft/min and 18" width of compaction {Dynapac LG300}	hrs	8.70	6.09	1.01		\$1,131.00	
TOTAL							71214.33

HORIZONTAL DIRECTIONAL DRILLING (ALTERATIVE A) - NATIVE BACKFILL Contd.							
	UNIT	QTTY	EQUIPMENT			LABOR	OTHER
			F-gal	G-lbs	S-\$	S-\$	
9. RESTORATION AND CLEAN-UP							
4 Inch fill of top soil	CY	174.00					261000
Placing and levelling-production rate of 25 CY/ hr{Estimate}	hrs	6.96	36.35	11.66		\$904.80	
Hauling fill material to site from 5 miles off site @35 mph {Estimate}	hrs/trip	0.29	39.12	3.85			
Seeding 100lb/Acre (43560 SF) {RS Means 2011}	lbs	1.20					1.20
Fertilizer 800lb/Acre (43560 SF) {RS Means 2011}	lbs	9.59					9.59
Seeding with fertilizer 2sec/SF {RS Means 2011}	hrs	0.29				\$37.70	
TOTAL							
10. DEMOBILIZATION							
Hauling Rig, downhole tools and pipe pulling devices to yard	hrs	3.83	60.03	5.07	\$88.17		
Hauling mixing system to yard	hrs	1.67	26.10	9.15			
Hauling backhoe loader to yard	hrs	3.83	60.03	5.07	\$88.17		
Hauling fusion machine to yard	hrs	3.83	60.03	5.07	\$88.17		
Moving vac truck to yard	hrs	1.67	39.17	7.21			
Hauling Dump truck to yard	hrs	1.67	26.10	2.57			
Loading and off loading	hrs	0.50					
Hauling at 45 mph + Trip From Yard	hrs	3.33					
TOTAL		2.17				\$281.67	

HORIZONTAL DIRECTIONAL DRILLING (ALTERATIVE A) - NATIVE BACKFILL Contd.

	UNIT	QTTY	EQUIPMENT			LABOR	OTHER
			F-gal	G-lbs	S-\$	S-\$	
11. EQUIPMENT							
1. Drill Rig: Ditch witch JT4020 (or similar)							
Engine-Cummins QSB6.7 (Diesel) Fuel Consumption	{Manufacturer}	Gal/hr	9.88				
Total Kerb Weight	{Manufacturer}	lbs	27700.00				
Operational Life	{Estimate}	hrs	10400.00				
2. 2 No. Mixing System: Ditch Witch FM 13V fluid management(or similar).							
2 No-Engine-Honda GX 390 (Gasoline) Fuel Consumption	{Manufacturer}	Gal/hr	2.14				
Engine-Mercedes-Benz OM501 LA (Diesel) Fuel	{Manufacturer}	Gal/hr	15.66				
Total Kerb Weight	{Manufacturer}	lbs	21950.00				
Operational Life	{Estimate}	hrs	4000.00				
3. Backhoe Loader: John Deere 410J(or similar)							
Engine-John Deere 4045H (Diesel) Fuel Consumption	{Manufacturer}	Gal/hr	5.22				
Total Kerb Weight	{Manufacturer}	lbs	15080.00				
Operational Life	{Estimate}	hrs	9000.00				
4. Fusion machine: Mc Elroy TracStar No. 618 Rolling (or similar)							
Engine-18 HP Air Cooled V-Twin Engine (Gasoline) Fuel	{Manufacturer}	Gal/hr	0.63				
Total Weight	{Manufacturer}	lbs	1899.00				
Operational Life	{Estimate}	hrs	7000.00				
5. Vacuum truck: Vactor Hydro-Excavator PD(or similar)							
Engine-430 hp (Diesel) Fuel	{Manufacturer}	Gal/hr	23.50				
Capacity	{Manufacturer}	Gal	2019.00				
Total Kerb Weight	{Manufacturer}	lbs	45000.00				
Operational Life	{Estimate}	hrs	10400.00				

HORIZONTAL DIRECTIONAL DRILLING (ALTERATIVE A) - NATIVE BACKFILL Contd.								
		UNIT	QTTY	EQUIPMENT			LABOR	OTHER
				F-gal	G-lbs	S-\$	S-\$	
6. Dump truck: Mercedes-Benz Actros								
Engine-Mercedes-Benz OM501 LA (Diesel) Fuel	{Manufacturer}	Gal/hr	15.66					
Capacity (struck)	{Manufacturer}	CY	19.90					
Total Kerb Weight	{Manufacturer}	lbs	19250.00					
Operational Life	{Estimate}	hrs	12480.00					
7. 3 No. Haul Truck: Mercedes-Benz Actros								
Engine-Mercedes-Benz OM501 LA (Diesel) Fuel	{Manufacturer}	Gal/hr	15.66					
Total Kerb Weight	{Manufacturer}	lbs	19250.00					
Operational Life	{Estimate}	hrs	14560.00					
8. Plate Compactor: Dynapac LG300 24" x 29" (or similar)								
Engine-Honda GX 270 (Gasoline) Fuel Consumption	{Manufacturer}	Gal/hr	0.70					
Total Weight	{Manufacturer}	lbs	580.00					
Operational Life	{Estimate}	hrs	5000.00					
12. LABOR								
Foreman	{Estimate}	\$/hr	32.00					
2 No. Operator	{Estimate}	\$/hr	32.00					
2 No. Laborers	{Estimate}	\$/hr	17.00					
TOTAL		\$/hr	130.00					
Trucks	{Estimate}	\$/hr	23.00					
GRAND TOTALS				2464.9	523.7	\$529.0	\$20,732.0	

HDD CALCULATIONS (Imported Backfill)

HORIZONTAL DIRECTIONAL DRILLING (ALTERATIVE A) IMPORTED BACKFILL							
STEPS	UNIT	QTTY	EQUIPMENT			LABOR	OTHER
			F-gal	G-lbs	S-\$	S-\$	
Mobilization							
Equipment Setup							
Pilot bore and tracking							
Reaming 12 inch							
Reaming 18 inch							
Pipe layout and fusion							
Pullback							
Connection							
Restoration and Clean-up							
Demobilization							
Equipment							
Labor							
1. MOBILIZATION							
Delivering Rig, downhole tools and pipe pulling devices on site	hrs	3.83	60.03	5.07	\$88.17		
Delivering mixing system on site	hrs	1.67	26.10	9.15			
Delivering backhoe loader on site	hrs	3.83	60.03	5.07	\$88.17		
Delivering fusion machine on site	hrs	3.83	60.03	5.07	\$88.17		
Delivering vac truck on site	hrs	1.67	39.17	7.21			
Delivering Dump truck on site	hrs	1.67	26.10	2.57			
Loading and off loading	hrs	0.50					
Hauling at 45 mph + Trip Back to Yard	hrs	3.33					
TOTAL		2.17				\$281.67	

HORIZONTAL DIRECTIONAL DRILLING (ALTERATIVE A) IMPORTED BACKFILL Contd.							
	UNIT	QTTY	EQUIPMENT			LABOR	OTHER
2. EQUIPMENT SETUP							
Positioning of the rig over the borehole centerline							
Stake-down of the rig							
Setup of all other equipment and materials							
Delineation of the entry and exit areas							
TOTAL	{Estimate}	hrs	1.00			\$130.00	
BORING							
Bores	No		12.00				
Pilot hole diameter	In		6.00				
Pre-reamed hole diameter	In		12.00				
Reamed hole diameter	In		18.00				
Drilling Fluid Viscosity	Sec/quart		50.00				
Water Viscosity = 26 Seconds/quart	Sec/quart		26.00				
Formation Flow Factor	{Mixed soil conditions- medium consistency}		3.00				
Pump Rated capacity = 70 gpm	gpm		70.00				
Pump efficiency			0.76				
Drill rod	ft		10.00				
Conection and disconnection of rods	Sec		15.00				
Factor for locating drill head communicating and correction	{Estimate}		1.50				
Management Factor	{Estimate}		1.20				
Site Factor	{Estimate}		1.20				

HORIZONTAL DIRECTIONAL DRILLING (ALTERATIVE A) IMPORTED BACKFILL Contd.							
	UNIT	QTTY	EQUIPMENT			LABOR	OTHER
3. PILOT BORE AND TRACKING							
Fluid vol	gal/ft	4.32					15047.71
Maximum Drilling rate, <i>t</i>	sec/ft	13.76	131.56	35.47		\$1,731.29	
TOTAL							
4. REAMING 12 In.							
Fluid vol	gal/ft	17.28					60190.86
Maximum Reaming rate, <i>t</i>	sec/ft	30.22	288.90	77.89		\$3,801.69	
TOTAL							
5. REAMING 18 In.							
Fluid vol	gal/ft	21.60					75238.58
Maximum Reaming rate, <i>t</i>	sec/ft	37.24	355.96	95.97		\$4,684.18	
TOTAL							150477.17
6. PIPE LAYOUT AND FUSION							
Wall thickness of 12 inch HDPE DR 11pipe (160 psi)	in	1.20					
Securing, facing, aligning, melting and joining	{Estimate} min	4.00					
Cooling under a pressure of 60 to 90 psi; at 90 sec/in.	{Estimate} sec	129.60					
Total per joint	sec	369.60					
TOTAL Fusion time	hrs	19.96	12.47	5.41		\$2,594.59	

HORIZONTAL DIRECTIONAL DRILLING (ALTERATIVE A) IMPORTED BACKFILL Contd.

	UNIT	QTTY	EQUIPMENT			LABOR	OTHER
7. PULLBACK							
Water to reduce bouyancy effect	gal/ft	4.24					22375.76
At 200 LF/hr	sec/ft	25.92	228.08	61.49		\$3,001.41	
Displaced mud (20% percolates in formation)	gal/ft	17.28	542.56	99.90			
Dump displaced mud 5 miles off site @35 mph {Estimate}	hrs/ trip	0.29	184.27	33.93			
TOTAL							
8. CONNECTIONS							
Excavation for fire hydrant assemblies: 3 ft x 6 ft {25% Swell factor}	CY	59.58					
Production 20 CY/ hr {Estimate}	hrs	2.98	15.56	4.99		\$387.29	
Excavation for tees and gate valves: 3 ft x 6 ft {25% Swell factor}	CY	27.08					
Production 20 CY/ hr {Estimate}	hrs	1.35	5.22	2.27		\$176.04	
Excavation for bore connections: 3 ft x 6ft {25% Swell factor}	CY	70.42					
Production 20 CY/ hr {Estimate}	hrs	3.52	18.39	5.90		\$457.71	
Hauling of excavated material 5 miles off site @35 mph {Estimate}	hrs/ trip	0.29	35.32	3.48			
Backfill for fire hydrant assemblies: 3 ft x 6 ft {10% Shrinkage factor}	CY	57.76					153069.89
Backfill for tees and gate valves: 3 ft x 6 ft {10% Shrinkage factor}	CY	26.26					69577.22
Backfill for bore connections: 3 ft x 6 ft {10% Shrinkage factor}	CY	68.26					180900.78
Hauling fill material to site from 5 miles off site @35 mph {Estimate}	hrs/trip	0.29	34.24	3.37			
Placing 1.5 min/ layer (10 layers + 2 layers of 6" Bedding) {Estimate}	hrs	8.70	45.44	14.58		\$1,131.00	
Compaction 5 passes in 6 Inch lifts to 95% Proctor Density (AASHTO T99)	SF	31320.00					
Compaction at 40ft/min and 18" width of compaction{Dynapac LG300}	hrs	8.70	6.09	1.01		\$1,131.00	
TOTAL							403547.89

HORIZONTAL DIRECTIONAL DRILLING (ALTERNATIVE A) IMPORTED BACKFILL Contd.

	UNIT	QTTY	EQUIPMENT			LABOR	OTHER
9. RESTORATION AND CLEAN-UP							
4 Inch fill of top soil	CY	174.00					261000.00
Placing and levelling-production rate of 25 CY/ hr {Estimate}	hrs	6.96	36.35	11.66		\$904.80	
Hauling fill material to site from 5 miles off site @35 mph {Estimate}	hrs/trip	0.29	39.12	3.85			
Seeding 100lb/Acre (43560 SF) {RS Means 2011}	lbs	1.20					1.20
Fertilizer 800lb/Acre (43560 SF) {RS Means 2011}	lbs	9.59					9.59
Seeding with fertilizer 2sec/SF {RS Means 2011}	hrs	0.29				\$37.70	
TOTAL							
10. DEMOBILIZATION							
Hauling Rig, downhole tools and pipe pulling devices to yard	hrs	3.83	60.03	5.07	\$88.17		
Hauling mixing system to yard	hrs	1.67	26.10	9.15			
Hauling backhoe loader to yard	hrs	3.83	60.03	5.07	\$88.17		
Hauling fusion machine to yard	hrs	3.83	60.03	5.07	\$88.17		
Moving vac truck to yard	hrs	1.67	39.17	7.21			
Hauling Dump truck to yard	hrs	1.67	26.10	2.57			
Loading and off loading	hrs	0.50					
Hauling at 45 mph + Trip From Yard	hrs	3.33					
TOTAL		2.17				\$281.67	

HORIZONTAL DIRECTIONAL DRILLING (ALTERATIVE A) IMPORTED BACKFILL Contd.

		UNIT	QTTY	EQUIPMENT	LABOR	OTHER
11. EQUIPMENT						
1. Drill Rig: Ditch witch JT4020 (or similar)						
Engine-Cummins QSB6.7 (Diesel) Fuel Consumption	{Manufacturer}	Gal/hr	9.88			
Total Kerb Weight	{Manufacturer}	lbs	27700.00			
Operational Life	{Estimate}	hrs	10400.00			
2. 2 No. Mixing System: Ditch Witch FM 13V fluid management						
2 No-Engine-Honda GX 390 (Gasoline) Fuel Consumption	{Manufacturer}	Gal/hr	2.14			
Engine-Mercedes-Benz OM501 LA (Diesel) Fuel	{Manufacturer}	Gal/hr	15.66			
Total Kerb Weight	{Manufacturer}	lbs	21950.00			
Operational Life	{Estimate}	hrs	4000.00			
3. Backhoe Loader: John Deere 410J(or similar)						
Engine-John Deere 4045H (Diesel) Fuel Consumption	{Manufacturer}	Gal/hr	5.22			
Total Kerb Weight	{Manufacturer}	lbs	15080.00			
Operational Life	{Estimate}	hrs	9000.00			
4. Fusion machine: Mc Elroy TracStar No. 618 Rolling (or similar)						
Engine-18 HP Air Cooled V-Twin Engine (Gasoline) Fuel	{Manufacturer}	Gal/hr	0.63			
Total Weight	{Manufacturer}	lbs	1899.00			
Operational Life	{Estimate}	hrs	7000.00			
5. Vacuum truck: Vactor Hydro-Excavator PD(or similar)						
Engine-430 hp (Diesel) Fuel	{Manufacturer}	Gal/hr	23.50			
Capacity	{Manufacturer}	Gal	2019.00			
Total Kerb Weight	{Manufacturer}	lbs	45000.00			
Operational Life	{Estimate}	hrs	10400.00			

HORIZONTAL DIRECTIONAL DRILLING (ALTERNATIVE A) IMPORTED BACKFILL Contd.

		UNIT	QTTY	EQUIPMENT			LABOR	OTHE R
6. Dump truck: Mercedes-Benz Actros								
Engine-Mercedes-Benz OM501 LA (Diesel) Fuel	{Manufacturer}	Gal/hr	15.66					
Capacity (struck)	{Manufacturer}	CY	19.90					
Total Kerb Weight	{Manufacturer}	lbs	19250.00					
Operational Life	{Estimate}	hrs	12480.00					
7. 3 No. Haul Truck: Mercedes-Benz Actros								
Engine-Mercedes-Benz OM501 LA (Diesel) Fuel	{Manufacturer}	Gal/hr	15.66					
Total Kerb Weight	{Manufacturer}	lbs	19250.00					
Operational Life	{Estimate}	hrs	14560.00					
8. Plate Compactor: Dynapac LG300 24" x 29" (or similar)								
Engine-Honda GX 270 (Gasoline) Fuel Consumption	{Manufacturer}	Gal/hr	0.70					
Total Weight	{Manufacturer}	lbs	580.00					
Operational Life	{Estimate}	hrs	5000.00					
12. LABOR								
Foreman	{Estimate}	\$/hr	32.00					
2 No. Operator	{Estimate}	\$/hr	32.00					
2 No. Laborers	{Estimate}	\$/hr	17.00					
TOTAL		\$/hr	130.00					
Trucks	{Estimate}	\$/hr	23.00					
GRAND TOTALS				2522.4	529.4	\$529.0	\$20,732.0	

APPENDIX G: ALTERNATIVE B CALCULATIONS (OPEN-CUT)

OPEN-CUT CALCULATIONS (Native Backfill)

OPEN-CUT (ALTERNATIVE B) – NATIVE BACKFILL							
	UNIT	QUANTITY	EQUIPMENT			LABOR	OTHER
			F-gal	G-lbs	S-\$	S-\$	
Mobilization							
Asphalt pavement saw cutting & Ripping							
Trench excavation							
Shoring							
Placing bedding material & Laying pipeline							
Backfilling & compacting							
Restoration & Site cleanup							
Demobilization							
Equipment							
Labor							
1. MOBILIZATION							
Delivering Excavator to site	hrs	2.72	42.63	3.60	\$62.61		
Delivering Back hoe loader and Asphalt Saw to site	hrs	2.72	42.63	3.60	\$62.61		
Delivering Dump truck to site 4 No.	hrs	1.11	69.60	6.86			
Delivering Wheel loader to site	hrs	2.72	42.63	3.60	\$62.61		
Loading and off loading	hrs	0.50					
Hauling at 45 mph + Trip Back to Yard	hrs	2.22					
TOTAL		1.61				\$299.67	

OPEN-CUT (ALTERATIVE B) – NATIVE BACKFILL Contd.							
	UNIT	QUANTITY	EQUIPMENT			LABOR	OTHER
			F-gal	G-lbs	S-\$	S-\$	
2. ASPHALT PAVEMENT SAW CUTTING & RIPPING							
Saw cutting 6 inch deep	LF	984.00					
At a cutting rate of 3ft/ min -2 Passes each 3" deep {Manufacturer}	hrs	10.93	11.70	0.59			
Water 1gal/ft {Estimate}	gal	1968.00					1968.00
Ripping 5 inch pavement	CY	18.98					
Production 5CY/hr {Estimate}	hrs	3.80	41.26	17.60		\$706.11	
Hauling of excavated material 5 miles off site @35 mph {Estimate}	hrs/ trip	0.29	4.47	0.44			
3. EXCAVATION							
Excavate base and compacted subgrade, 19 inch{10% Shrinkage factor}	CY	100.26					
Production 25CY/hr {Estimate}	hrs	4.01	43.58	18.59		\$745.94	
Excavate trench to 6.5 inch below {25% Swell factor}	CY	3858.33					
Production 25CY/hr {Estimate}	hrs	154.33	1677.17	715.34		\$28,706.00	
Excavate to 6.5 inch below for connections: 3 ft x 6 ft {25% Swell factor}	CY	86.67					
Production 25 CY/ hr {Estimate}	hrs	3.47	37.67	16.07		\$644.80	
Hauling of excavated material 5 miles off site @35 mph {Estimate}	hrs/ trip	0.29	138.89	13.68			
4. SHORING							
3 No. 5'Aluminum hydraulic shores (Std Vertical rail) 2.94plf {Manf.}	lbs	88.20					88.20
Setup 2min/shore and 3 shores/ 20 ft run	hrs/run	0.10					

OPEN-CUT (ALTERATIVE B) – NATIVE BACKFILL Contd.

	UNIT	QUANTITY	EQUIPMENT			LABOR	OTHER
			F-gal	G-lbs	S-\$	S-\$	
5. BEDDING MATERIAL AND LAYING PIPELINE							
Placing 12 inch bedding material {10% Shrinkage factor}	CY	686.97					1820468
Production 25 CY/ hr {Estimate}	hrs	27.48	298.62	111.09			
Light compaction of bedding material, laying and pulling the pipe to place using 1ton come-along(10 min for 20ft run) {Estimate}	hrs	44.00	229.79	73.72			
6. BACKFILLING AND COMPACTING							
Backfill trench to subgrade level {10% Shrinkage factor}	CY	248.01					
Production 25CY/hr {Estimate}	hrs	9.92	107.81	40.11			
Backfill trench to topsoil level {10% Shrinkage factor}	CY	3183.87					
Production 25CY/hr {Estimate}	hrs	127.35	1383.99	514.87			
Backfill to topsoil level at connections 3 ft x 6 ft {10% Shrinkage factor}	CY	76.60					
Production 25CY/hr {Estimate}	hrs	3.06	33.30	12.39			
Hauling fill material from 5 miles off site @35 mph Bedding {Estimate}	hrs/trip	0.29	154.45	15.21			
Compaction of backfill (15 min for a 20ft run 1 ft deep) {Estimate}	hrs	383.70	2003.88	642.91			
TOTAL							1820468
7. RESTORATION AND SITE CLEANUP							
Flexible Pavement restoration 1ft on either side beyond trench width	SF	2214.00					2214.00
4 Inch fill of top soil	CY	147.78					221667
Placing and levelling-production rate of 25 CY/ hr {Estimate}	hrs	5.91	64.24	23.90		\$1,099.47	
Seeding 100lb/Acre (43560 SF) {RS Means 2011}	lbs	27.48					27.48
Fertilizer 800lb/Acre (43560 SF) {RS Means 2011}	lbs	219.83					219.83
Seeding with fertilizer 2sec/SF {RS Means 2011}	hrs	6.65				\$1,236.90	

OPEN-CUT (ALTERATIVE B) – NATIVE BACKFILL Contd.

	UNIT	QUANTITY	EQUIPMENT			LABOR	OTHER
			F-gal	G-lbs	S-\$	S-\$	
8. DEMOBILIZATION							
Moving Excavator to yard	hrs	2.72	42.63	3.60	\$62.61		
Moving Back hoe loader and Asphalt Saw to yard	hrs	2.72	42.63	3.60	\$62.61		
Moving Dump truck to yard 4 No.	hrs	1.11	69.60	6.86			
Moving Wheel loader to yard	hrs	2.72	42.63	3.60	\$62.61		
Loading and off loading	hrs	0.50					
Hauling at 45 mph + Trip From Yard	hrs	2.22					
TOTAL	hrs	1.61				\$299.67	
9. EQUIPMENT							
1. 4 No. Dump truck: Mercedes-Benz Actros (or similar)							
Engine-Mercedes-Benz OM501 LA (Diesel) Fuel	{Manufacturer} Gal/hr	15.66					
Capacity (struck)	{Manufacturer} CY	19.90					
Total Kerb Weight	{Manufacturer} lbs	19250.00					
Operational Life	{Estimate} hrs	12480.00					
2. 3 No. Haul Truck: Mercedes-Benz Actros (or similar)							
Engine-Mercedes-Benz OM501 LA (Diesel) Fuel	{Manufacturer} Gal/hr	15.66					
Total Kerb Weight	{Manufacturer} lbs	19250.00					
Operational Life	{Estimate} hrs	14560.00					
3. Excavator: CAT 324 D (or similar)							
Engine-CAT C7 ACERT (Diesel) Fuel Consumption	Gal/hr	10.87					
Total Kerb Weight	{Manufacturer} lbs	46350.00					
Operational Life	{Estimate} hrs	10000.00					

OPEN-CUT (ALTERNATIVE B) – NATIVE BACKFILL Contd.

	UNIT	QUANTITY	EQUIPMENT			LABOR	OTHER
			F-gal	G-lbs	S-\$	S-\$	
4. Backhoe Loader: John Deere 410J (or similar)							
Engine-John Deere 4045H (Diesel) Fuel Consumption {Manufacturer}	Gal/hr	5.22					
Total Kerb Weight {Manufacturer}	lbs	15080.00					
Operational Life {Estimate}	hrs	9000.00					
5. Asphalt Saw: Dynapac ORKA 350/450 (or similar)							
Engine-Honda GX 390 QXC4 Engine (Gasoline) Fuel {Manufacturer}	Gal/hr	1.07					
Total Weight {Manufacturer}	lbs	215.60					
Operational Life {Estimate}	hrs	4000.00					
6. Wheel loader: CAT 950H (or similar)							
Engine-CAT C7 ACERT (Diesel) Fuel Consumption	Gal/hr	10.87					
Total Kerb Weight {Manufacturer}	lbs	40428.00					
Operational Life {Estimate}	hrs	10000.00					
10. LABOR							
Foreman {Estimate}	\$/hr	28.00					
3 No. Operator {Estimate}	\$/hr	28.00					
2 Truck {Estimate}	\$/hr	23.00					
2 No. Laborers {Estimate}	\$/hr	14.00					
TOTAL	\$/hr	186.00					
Haul Trucks Drivers {Estimate}	\$/hr	23.00					
GRAND TOTALS			6625.78	2251.8	\$375.6	\$33,738.5	

OPEN-CUT CALCULATIONS (Imported Backfill)

OPEN-CUT (ALTERATIVE B) – IMPORTED BACKFILL							
	UNIT	QUANTITY	EQUIPMENT			LABOR	OTHER
			F-gal	G-lbs	S-\$	S-\$	
Mobilization							
Asphalt pavement saw cutting & Ripping							
Trench excavation							
Shoring							
Placing bedding material & Laying pipeline							
Backfilling & compacting							
Restoration & Site cleanup							
Demobilization							
Equipment							
Labor							
1. MOBILIZATION							
Delivering Excavator to site	hrs	2.72	42.63	3.60	\$62.61		
Delivering Back hoe loader and Asphalt Saw to site	hrs	2.72	42.63	3.60	\$62.61		
Delivering Dump truck to site 4 No.	hrs	1.11	69.60	6.86			
Delivering Wheel loader to site	hrs	2.72	42.63	3.60	\$62.61		
Loading and off loading	hrs	0.50					
Hauling at 45 mph + Trip Back to Yard	hrs	2.22					
TOTAL		1.61				\$299.67	

OPEN-CUT (ALTERATIVE B) – IMPORTED BACKFILL Contd.

	UNIT	QUANTITY	EQUIPMENT			LABOR	OTHER
			F-gal	G-lbs	S-\$	S-\$	
2. ASPHALT PAVEMENT SAW CUTTING & RIPPING							
Saw cutting 6 inch deep	LF	984.00					
At a cutting rate of 3ft/ min -2 Passes each 3" deep {Manufacturer}	hrs	10.93	11.70	0.59			
Water 1gal/ft {Estimate}	gal	1968.00					1968.00
Ripping 5 inch pavement	CY	18.98					
Production 5CY/hr {Estimate}	hrs	3.80	41.26	17.60		\$706.11	
Hauling of excavated material 5 miles off site @35 mph {Estimate}	hrs/ trip	0.29	4.47	0.44			
3. EXCAVATION							
Excavate base and compacted subgrade, 19 inch{10% Shrinkage factor}	CY	100.26					
Production 25CY/hr {Estimate}	hrs	4.01	43.58	18.59		\$745.94	
Excavate trench to 6.5 inch below {25% Swell factor}	CY	3858.33					
Production 25CY/hr {Estimate}	hrs	154.33	1677.17	715.34		\$28,706.00	
Excavate to 6.5 inch below for connections: 3 ft x 6 ft{25% Swell factor}	CY	86.67					
Production 25 CY/ hr {Estimate}	hrs	3.47	37.67	16.07		\$644.80	
Hauling of excavated material 5 miles off site @35 mph {Estimate}	hrs/ trip	0.29	909.48	89.59			
4. SHORING							
3 No. 5' Aluminum hydraulic shores (Std Vertical rail) 2.94 plf {Manf}	lbs	88.20					88.20
Setup 2min/shore and 3 shores/ 20 ft run	hrs/run	0.10					

OPEN-CUT (ALTERATIVE B) – IMPORTED BACKFILL Contd.

	UNIT	QUANTITY	EQUIPMENT			LABOR	OTHER
			F-gal	G-lbs	S-\$	S-\$	
5. BEDDING MATERIAL AND LAYING PIPELINE							
Placing 6 inch bedding material {10% Shrinkage factor}	CY	347.19					920056
Production 25 CY/ hr {Estimate}	hrs	13.89	150.92	56.14			
Light compaction of bedding material, laying and pulling the pipe to place using 1ton come-along(10 min for 20ft run) {Estimate}	hrs	44.00	229.79	73.72			
6. BACKFILLING AND COMPACTING							
Backfill trench to subgrade level {10% Shrinkage factor}	CY	279.67					741134
Production 25CY/hr {Estimate}	hrs	11.19	121.57	45.23			
Backfill trench to topsoil level {10% Shrinkage factor}	CY	3491.99					9253771
Production 25CY/hr {Estimate}	hrs	139.68	1517.93	564.70			
Backfill to topsoil level at connections 3 ft x 6 ft{10% Shrinkage factor}	CY	84.02					222647.11
Production 25CY/hr {Estimate}	hrs	3.36	36.52	13.59			
Hauling fill material to site from 5 miles off site @35 mph {Estimate}	hrs/trip	0.29	866.86	85.39			
Compaction of backfill (5 min for a 20ft run 1 ft deep) {Estimate}	hrs	127.90	667.96	214.30			
TOTAL							11137608
7. RESTORATION AND SITE CLEANUP							
Flexible Pavement restoration 1ft on either side beyond trench width	SF	2214.00					2214.00
4 Inch fill of top soil	CY	147.78					221667
Placing and levelling-production rate of 25 CY/ hr {Estimate}	hrs	5.91	64.24	23.90		\$1,099.47	
Seeding 100lb/Acre (43560 SF) {RS Means 2011}	lbs	27.48					27.48
Fertilizer 800lb/Acre (43560 SF) {RS Means 2011}	lbs	219.83					219.83
Seeding with fertilizer 2sec/SF {RS Means 2011}	hrs	6.65				\$1,236.90	

OPEN-CUT (ALTERATIVE B) – IMPORTED BACKFILL Contd.

	UNIT	QUANTITY	EQUIPMENT			LABOR	OTHER
			F-gal	G-lbs	S-\$	S-\$	
8. DEMOBILIZATION							
Moving Excavator to yard	hrs	2.72	42.63	3.60	\$62.61		
Moving Back hoe loader and Asphalt Saw to yard	hrs	2.72	42.63	3.60	\$62.61		
Moving Dump truck to yard 4 No.	hrs	1.11	69.60	6.86			
Moving Wheel loader to yard	hrs	2.72	42.63	3.60	\$62.61		
Loading and off loading	hrs	0.50					
Hauling at 45 mph + Trip From Yard	hrs	2.22					
TOTAL	hrs	1.61				\$299.67	
9. EQUIPMENT							
1. 4 No. Dump truck: Mercedes-Benz Actros (or similar)							
Engine-Mercedes-Benz OM501 LA (Diesel) Fuel	{Manufacturer}	Gal/hr	15.66				
Capacity (struck)	{Manufacturer}	CY	19.90				
Total Kerb Weight	{Manufacturer}	lbs	19250.00				
Operational Life	{Estimate}	hrs	12480.00				
2. 3 No. Haul Truck: Mercedes-Benz Actros (or similar)							
Engine-Mercedes-Benz OM501 LA (Diesel) Fuel	{Manufacturer}	Gal/hr	15.66				
Total Kerb Weight	{Manufacturer}	lbs	19250.00				
Operational Life	{Estimate}	hrs	14560.00				
3. Excavator: CAT 324 D (or similar)							
Engine-CAT C7 ACERT (Diesel) Fuel Consumption		Gal/hr	10.87				
Total Kerb Weight	{Manufacturer}	lbs	46350.00				
Operational Life	{Estimate}	hrs	10000.00				

OPEN-CUT (ALTERATIVE B) – IMPORTED BACKFILL Contd.

	UNIT	QUANTITY	EQUIPMENT			LABOR	OTHER
			F-gal	G-lbs	S-\$	S-\$	
4. Backhoe Loader: John Deere 410J (or similar)							
Engine-John Deere 4045H (Diesel) Fuel Consumption	{Manufacturer}	Gal/hr	5.22				
Total Kerb Weight	{Manufacturer}	lbs	15080.00				
Operational Life	{Estimate}	hrs	9000.00				
5. Asphalt Saw: Dynapac ORKA 350/450 (or similar)							
Engine-Honda GX 390 QXC4 Engine (Gasoline) Fuel	{Manufacturer}	Gal/hr	1.07				
Total Weight	{Manufacturer}	lbs	215.60				
Operational Life	{Estimate}	hrs	4000.00				
6. Wheel loader: CAT 950H (or similar)							
Engine-CAT C7 ACERT (Diesel) Fuel Consumption		Gal/hr	10.87				
Total Kerb Weight	{Manufacturer}	lbs	40428.00				
Operational Life	{Estimate}	hrs	10000.00				
10. LABOR							
Foreman	{Estimate}	\$/hr	28.00				
3 No. Operator	{Estimate}	\$/hr	28.00				
2 Truck	{Estimate}	\$/hr	23.00				
2 No. Laborers	{Estimate}	\$/hr	14.00				
TOTAL		\$/hr	186.00				
Haul Trucks Drivers	{Estimate}	\$/hr	23.00				
GRAND TOTALS							
				6776.1	1970.5	\$375.7	\$33,738.6

OPEN-CUT CALCULATIONS (Unpaved)

OPEN-CUT (ALTERATIVE A) - UNPAVED							
	UNIT	QUANTITY	EQUIPMENT			LABOR	OTHER
			F-gal	G-lbs	S-\$	S-\$	
Mobilization							
Asphalt pavement saw cutting & Ripping							
Trench excavation							
Shoring							
Placing bedding material & Laying pipeline							
Backfilling & compacting							
Restoration & Site cleanup							
Demobilization							
Equipment							
Labor							
1. MOBILIZATION							
Delivering Excavator to site	hrs	2.72	42.63	3.60	\$62.61		
Delivering Back hoe loader and Asphalt Saw to site	hrs	2.72	42.63	3.60	\$62.61		
Delivering Dump truck to site 4 No.	hrs	1.11	69.60	6.86			
Delivering Wheel loader to site	hrs	2.72	42.63	3.60	\$62.61		
Loading and off loading	hrs	0.50					
Hauling at 45 mph + Trip Back to Yard	hrs	2.22					
TOTAL		1.61				\$299.67	

OPEN-CUT (ALTERATIVE A) - UNPAVED Contd.

	UNIT	QUANTITY	EQUIPMENT			LABOR	OTHER
			F-gal	G-lbs	S-\$	S-\$	
2. ASPHALT PAVEMENT SAW CUTTING & RIPPING							
Saw cutting 6 inch deep	LF	0.00					
At a cutting rate of 3ft/ min -2 Passes each 3" deep {Manufacturer}	hrs	0.00	0.00	0.00			
Water 1gal/ft {Estimate}	gal	0.00					0.00
Ripping 5 inch pavement	CY	0.00					
Production 5CY/hr {Estimate}	hrs	0.00	0.00	0.00		\$0.00	
Hauling of excavated material 5 miles off site @35 mph {Estimate}	hrs/ trip	0.00	0.00	0.00			
3. EXCAVATION							
Excavate base and compacted subgrade, 19 inch{10% Shrinkage factor}	CY	0.00					
Production 25CY/hr {Estimate}	hrs	0.00	0.00	0.00		\$0.00	
Excavate trench to 6.5 inch below {25% Swell factor}	CY	3972.22					
Production 25CY/hr {Estimate}	hrs	158.89	1726.68	736.45		\$29,553.33	
Excavate to 6.5 inch below for connections: 3 ft x 6 ft{25% Swell factor}	CY	86.67					
Production 25 CY/ hr {Estimate}	hrs	3.47	37.67	16.07		\$644.80	
Hauling of excavated material 5 miles off site @35 mph {Estimate}	hrs/ trip	0.29	138.89	13.68			
4. SHORING							
3 No. 5'Aluminum hydraulic shores (Std Vertical rail) 2.94 plf {Manuf}	lbs	88.20					88.20
Setup 2min/shore and 3 shores/ 20 ft run	hrs/run	0.10					

OPEN-CUT (ALTERATIVE A) - UNPAVED Contd.							
	UNIT	QUANTITY	EQUIPMENT			LABOR	OTHER
			F-gal	G-lbs	S-\$	S-\$	
5. BEDDING MATERIAL AND LAYING PIPELINE							
Placing 12 inch bedding material {10% Shrinkage factor}	CY	686.97					1820468
Production 25 CY/ hr {Estimate}	hrs	27.48	298.62	111.09			
Light compaction of bedding material, laying and pulling the pipe to place using 1ton come-along(10 min for 20ft run) {Estimate}	hrs	44.00	229.79	73.72			
6. BACKFILLING AND COMPACTING							
Backfill trench to subgrade level {10% Shrinkage factor}	CY	0.00					
Production 25CY/hr {Estimate}	hrs	0.00	0.00	0.00			
Backfill trench to topsoil level {10% Shrinkage factor}	CY	3511.04					
Production 25CY/hr {Estimate}	hrs	140.44	1526.21	567.78			
Backfill to topsoil level at connections 3 ft x 6 ft {10% Shrinkage factor}	CY	76.60					
Production 25CY/hr {Estimate}	hrs	3.06	33.30	12.39			
Hauling fill material from 5 miles off site @35 mph Bedding {Estimate}	hrs/trip	0.29	154.45	15.21			
Compaction of backfill (15 min for a 20ft run 1 ft deep) {Estimate}	hrs	396.00	2068.12	663.52			
TOTAL							1820468
7. RESTORATION AND SITE CLEANUP							
Flexible Pavement restoration 1ft on either side beyond trench width	SF	0.00					0.00
4 Inch fill of top soil	CY	162.96					244444
Placing and levelling-production rate of 25 CY/ hr {Estimate}	hrs	6.52	70.84	26.35		\$1,212.44	
Seeding 100lb/Acre (43560 SF) {RS Means 2011}	lbs	30.30					30.30
Fertilizer 800lb/Acre (43560 SF) {RS Means 2011}	lbs	242.42					242.42
Seeding with fertilizer 2sec/SF {RS Means 2011}	hrs	7.33				\$1,364.00	

OPEN-CUT (ALTERATIVE A) - UNPAVED Contd.

	UNIT	QUANTITY	EQUIPMENT			LABOR	OTHER
			F-gal	G-lbs	S-\$	S-\$	
8. DEMOBILIZATION							
Moving Excavator to yard	hrs	2.72	42.63	3.60	\$62.61		
Moving Back hoe loader and Asphalt Saw to yard	hrs	2.72	42.63	3.60	\$62.61		
Moving Dump truck to yard 4 No.	hrs	1.11	69.60	6.86			
Moving Wheel loader to yard	hrs	2.72	42.63	3.60	\$62.61		
Loading and off loading	hrs	0.50					
Hauling at 45 mph + Trip From Yard	hrs	2.22					
TOTAL	hrs	1.61				\$299.67	
9. EQUIPMENT							
1. 4 No. Dump truck: Mercedes-Benz Actros (or similar)							
Engine-Mercedes-Benz OM501 LA (Diesel) Fuel	{Manufacturer} Gal/hr	15.66					
Capacity (struck)	{Manufacturer} CY	19.90					
Total Kerb Weight	{Manufacturer} lbs	19250.00					
Operational Life	{Estimate} hrs	12480.00					
2. 3 No. Haul Truck: Mercedes-Benz Actros (or similar)							
Engine-Mercedes-Benz OM501 LA (Diesel) Fuel	{Manufacturer} Gal/hr	15.66					
Total Kerb Weight	{Manufacturer} lbs	19250.00					
Operational Life	{Estimate} hrs	14560.00					
3. Excavator: CAT 324 D (or similar)							
Engine-CAT C7 ACERT (Diesel) Fuel Consumption	Gal/hr	10.87					
Total Kerb Weight	{Manufacturer} lbs	46350.00					
Operational Life	{Estimate} hrs	10000.00					

OPEN-CUT (ALTERATIVE A) - UNPAVED Contd.

	UNIT	QUANTITY	EQUIPMENT			LABOR	OTHER
			F-gal	G-lbs	S-\$	S-\$	
4. Backhoe Loader: John Deere 410J (or similar)							
Engine-John Deere 4045H (Diesel) Fuel Consumption {Manufacturer}	Gal/hr	5.22					
Total Kerb Weight {Manufacturer}	lbs	15080.00					
Operational Life {Estimate}	hrs	9000.00					
5. Asphalt Saw: Dynapac ORKA 350/450 (or similar)							
Engine-Honda GX 390 QXC4 Engine (Gasoline) Fuel {Manufacturer}	Gal/hr	1.07					
Total Weight {Manufacturer}	lbs	215.60					
Operational Life {Estimate}	hrs	4000.00					
6. Wheel loader: CAT 950H (or similar)							
Engine-CAT C7 ACERT (Diesel) Fuel Consumption	Gal/hr	10.87					
Total Kerb Weight {Manufacturer}	lbs	40428.00					
Operational Life {Estimate}	hrs	10000.00					
10. LABOR							
Foreman {Estimate}	\$/hr	28.00					
3 No. Operator {Estimate}	\$/hr	28.00					
2 Truck {Estimate}	\$/hr	23.00					
2 No. Laborers {Estimate}	\$/hr	14.00					
TOTAL	\$/hr	186.00					
Haul Trucks Drivers {Estimate}	\$/hr	23.00					
GRAND TOTALS			6679.52	2271.57	\$375.67	\$33,373.91	

APPENDIX H: ASPHALT PAVEMENT TRANSFORMITY CALCULATIONS

AGGREGATED EMERGY INPUT SOURCE DATA FOR ASPHALT CONCRETE
PAVEMENT SYSTEM

EVE PHASE	EMERGY INPUT SOURCE DATA				TOTAL PHASE EMERGY
	ENVIRON (E)	FUEL ENERGY (F)	GOODS (G)	SERVICES (S)	
A-C	6.40E+18	8.49E+17	8.01E+17	8.01E+17	8.85E+18
D	0.00E+00	0.00E+00	0.00E+00	0.00E+00	0.00E+00
E	0.00E+00	0.00E+00	0.00E+00	0.00E+00	0.00E+00
F	8.67E+13	2.34E+16	3.39E+15	1.82E+16	4.51E+16
G	6.69E+18	1.84E+18	1.68E+18	1.69E+18	1.19E+19
H	3.34E+13	9.57E+15	1.25E+15	6.54E+15	1.74E+16
I	0.00E+00	0.00E+00	0.00E+00	0.00E+00	0.00E+00
J	0.00E+00	0.00E+00	0.00E+00	0.00E+00	0.00E+00
TOTALS	1.31E+19	2.72E+18	2.49E+18	2.52E+18	2.08E+19
SEJs PER SF	1.66E+14	3.46E+13	3.16E+13	3.19E+13	2.64E+14

Data from aggregated table (Roudebush, 1997).

APPENDIX I: DRILLING FLUID TRANSFORMITY CALCULATION

Drilling Fluid Contents

- Water
- Bentonite (Montmorillonite clay)
- PHPA Polymer (Stabilizer for shale and clay)
- Dry cellulosic polymer (For filtration control)
- Soda Ash (Na_2CO_3)

Water by volume at room temperature,

1 gal = 8.345 lbs

100gal = 834.5 lbs

Content	lbs/100 gal	Ratio (%)
Water	834.5	96.14
Bentonite	30	3.46
PHPA Polymer	0.5	0.06
Dry cellulosic polymer	1.5	0.17
Soda Ash	1.5	0.17
Totals	868	100

Estimates From Baroid Industrial Drilling Products

EMERGY for Bentonite

Bentonite-based drilling fluid

Water transformity = $3.30\text{E}+07$ sej/ lb { Appendix C }

Bentonite transformity = $7.76\text{E}+11$ sej/ lb { Appendix C }

PHPA polymer transformity = $1.45\text{E}+12$ sej/ lb { Appendix C }

Dry cellulosic polymer transformity = $1.45\text{E}+12$ sej/ lb { Appendix C }

Soda Ash (Na_2CO_3) transformity = $7.35\text{E}+08$ sej/ lb { Appendix C }

Quantities for the drilling fluid

Material	Ratio	Transformity	Sej
Water	96.14%	3.30E+07	3.17E+07
Bentonite	3.46%	7.76E+11	2.68E+10
PHPA Polymer	0.06%	1.45E+12	8.70E+08
Dry Cellulosic Polymer	0.17%	1.45E+12	2.47E+09
Soda Ash	0.17%	7.35E+08	1.25E+06
Totals	100.00%		3.02E+10

1 pound of drilling fluid = 3.02E+10 sej

1 lb = .12 gal

{Table above}

Therefore, the transformity for the drilling fluid = **2.52E+11 sej/ gal**

APPENDIX J: GLOSSARY

Construction Method. All alternatives that consume environment (E), fuel energy (F), goods (G), and services (S) inputs.

EMERGY. A scientific based measure of wealth that puts raw materials, commodities, goods, and services on a common basis, the energy of one kind (usually solar) that has to be used up directly and indirectly to make a product or service (Odum&Odum, 2006).

EMERGY analysis. Calculation and comparison of EMERGY inputs and outputs of a system (Roudebush, 1997).

Environmental value engineering (EVE). Copyright © Wilfred H. Roudebush 1990. An environmental life cycle analysis methodology that evaluates the environmental impact and contribution of built alternatives in terms of EMERGY through ten life cycle phases namely: natural resource formation, natural resource exploration and extraction, material production, design, component production, construction (assembly), use, demolition, natural resource recycling, and disposal.

Horizontal Directional Drilling. A trenchless methodology that consists of a rig that is used to install a product pipe, cable or conduit in three phases namely: pilot bore, back reaming, and product pullback.

Life cycle assessment (LCA). A technique to assess each and every impact associated with all the stages of a process from cradle-to-grave.

Solar emjoule (SEJ). The solar joules previously required through direct and indirect transformations to produce all the inputs for a service or product.

Solar transformity. The solar EMERGY per unit of product or output flow.

Transformity. The ratio of EMERGY to available energy (Odum, 1998), or the EMERGY of one type required to make a unit of energy of another type (Roudebush, 1997).